

Indholdsfortegnelse:

Smart køle-/fryseskabe	side 2
Master køle-/fryse/combi/fiskeskabe	side 10
Indkørings-/gennemkøringskøleskabe GN 2/1	side 40
Smart køleborde GN1/1	side 45
Master køleborde 600	side 49
Master køle-/fryseborde GN1/1	side 56
Saladetter GN1/1	side 78
Blæstkølere-/frysere	side 84

CATERING

FastShop.dk - 35 81 67 00

Egenskaber

Udvendig/indvendig i rustfrit AISI 304 stål

Isolationstykkelse 75 mm

Afrundede hjørner

Højdejusterbare ben (100-150 mm) i rustfrit AISI 304 stål

Selvlukkende vendbare døre, der kan åbnes 105°

Ergonomiske greb i fuld højde i PVC

Magnet tætningslister – nemme at rengøre og udskifte

Dørlås

Aftagelige hyldevanger og hyldevinkler i rustfrit AISI 304 stål

Korrosionsbestandige rilsan hylder GN2/1. Option: Rustfri hylder

Konstruerede for drift ved omgivelsestemperaturer på op til +43° C

Ventileret kulde

Coated fordampner (cataphoresis) for at modvirke tæring

Fuldt udskifteligt kølesystem

Automatisk afrimning (styret af føler)

Genfordampning af tøvand

Elektronisk styring



Smart 600 liter



Side 5

Smart 700 liter



Side 6

Smart 1200 liter



Side 7

Smart 1400 liter



Side 8



Dybde 715 mm

600 liter

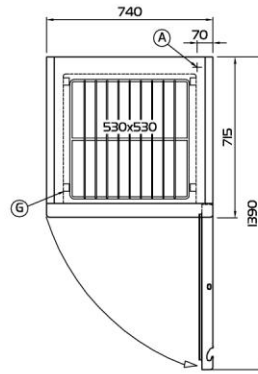
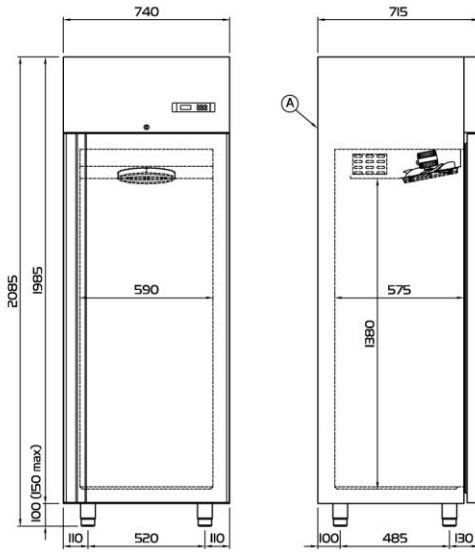

(A) POWER SUPPLY CABLE OUTLET

(G) RACKS PITCH

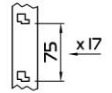

1200 liter

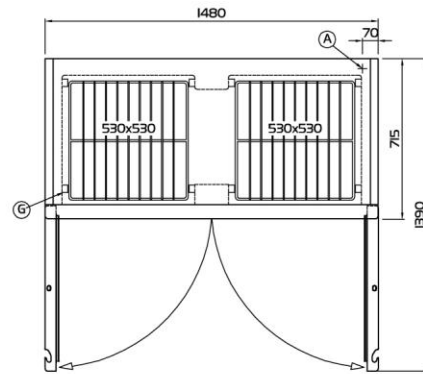
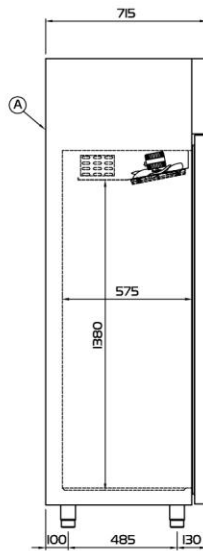
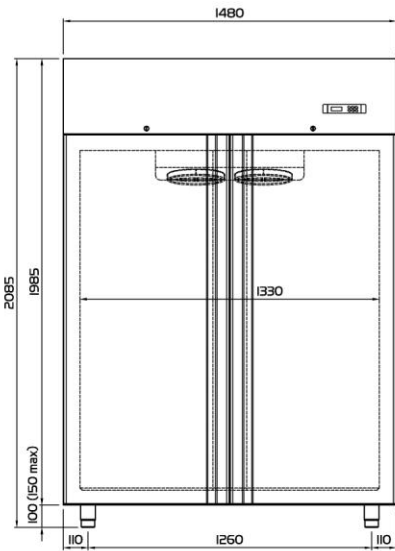

1200 liter fryser

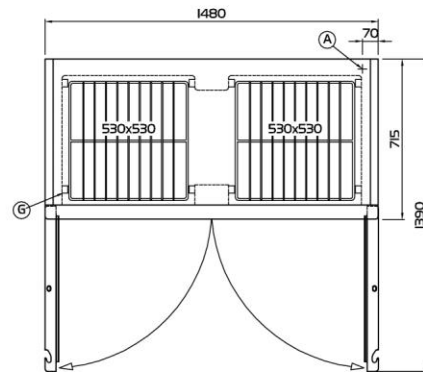
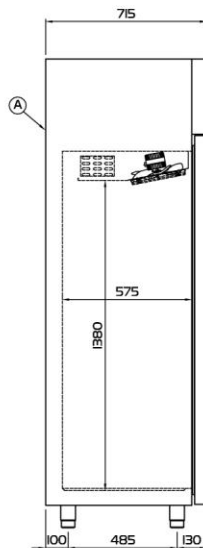
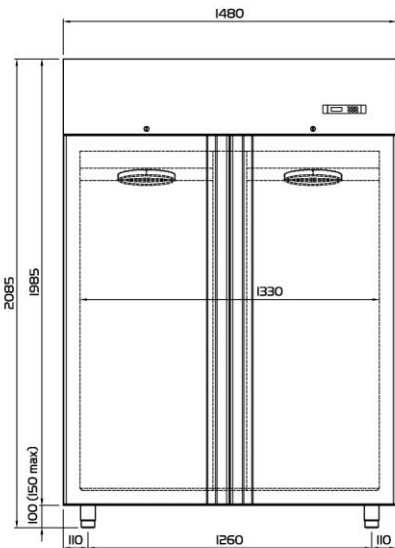

* Dual refrigeration system
in freezer versions

Dybde 815 mm

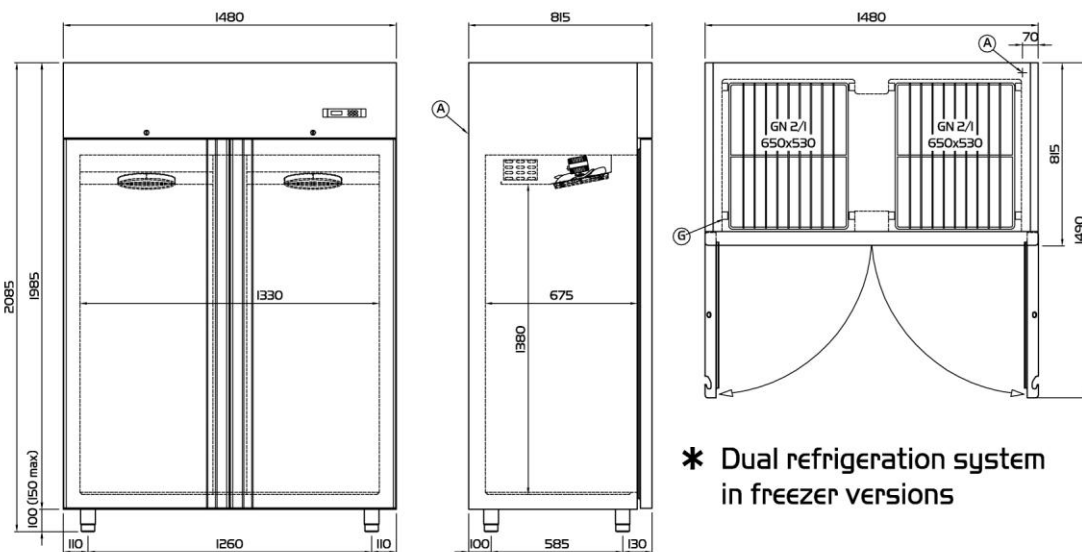
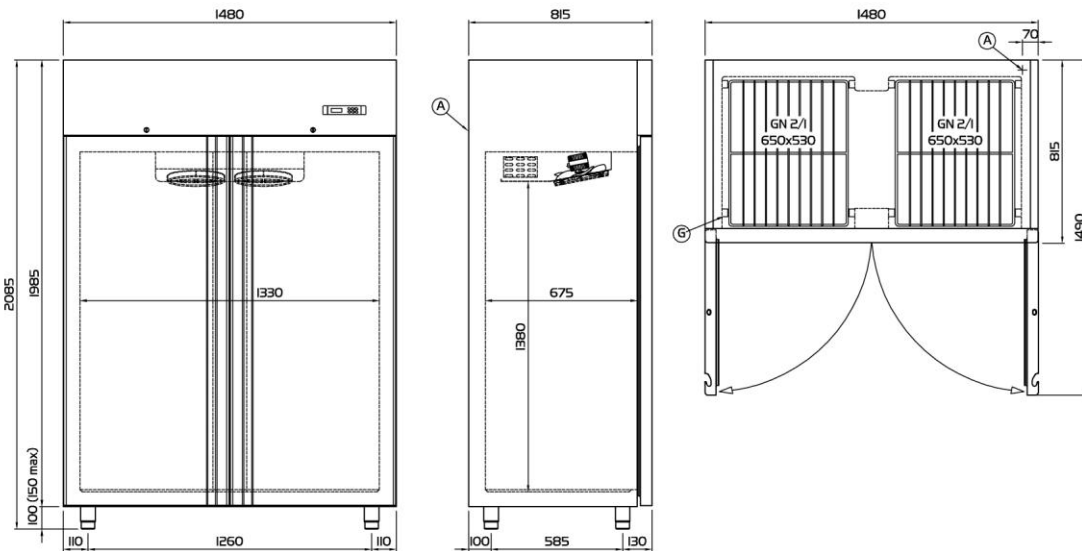
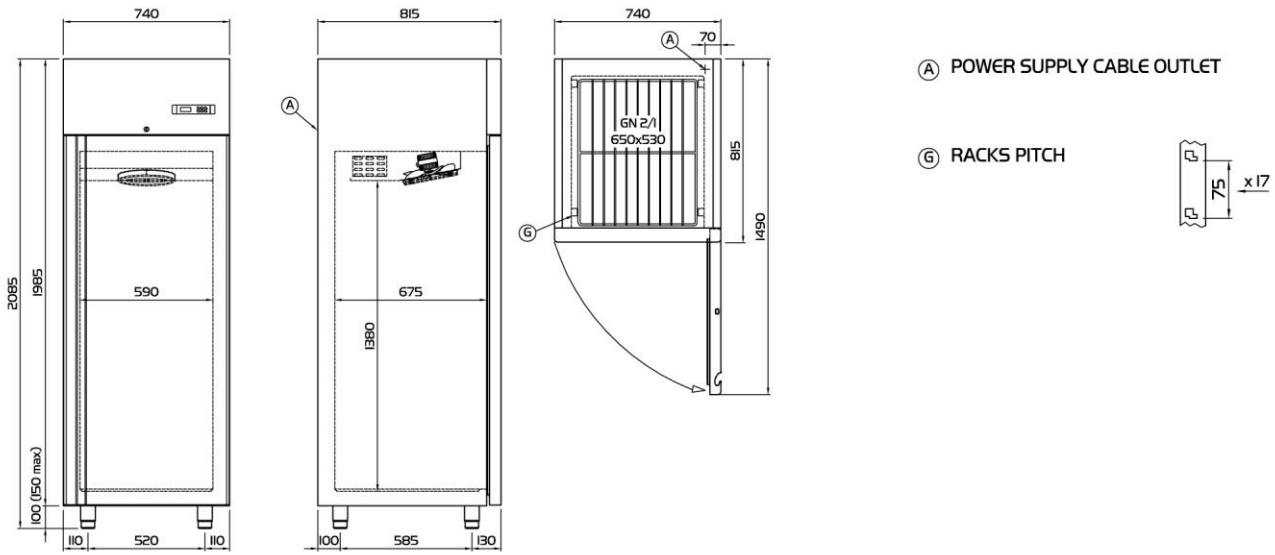

700 liter

1400 liter

1400 liter fryser

Catering

Skabe

Smart 600 liters

Dybde 715 mm

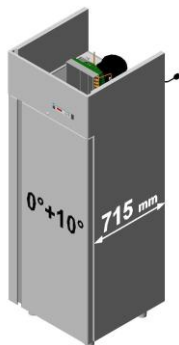

					Pris i DKK
Indbygget kompressor A60/1NE	Hylde 53x53	Hyldevinkler	Vægt	Dimensioner	Ekskl. moms og afgifter
A120601001	3	3	120	740x715x2085	13.448,00

					Pris i DKK
For separat kompressor A60/1NER	Hylde 53x53	Hyldevinkler	Vægt	Dimensioner	Ekskl. moms og afgifter
A120611001	3	3	110	740x715x2085	12.428,00

Kompressoraggregat D181106110	Luftkølet Max afstand 8 m	Vægt	Dimensioner	Ekskl. moms og afgifter
		25	430x450x300	Indhent tilbud

Ei-tilslutning	230 / 50Hz
Optagen effekt	328 W - 1,8 A
Kølekapacitet	368 W*
Kølemiddel	R404a
*Ford. -10°C kondens. 54,4°C	

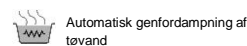
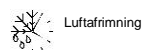

					Pris i DKK
Indbygget kompressor A60/1ME	Hylde 53x53	Hyldevinkler	Vægt	Dimensioner	Ekskl. moms og afgifter
A120602001	3	3	120	740x715x2085	13.822,00

					Pris i DKK
For separat kompressor A60/1MER	Hylde 53x53	Hyldevinkler	Vægt	Dimensioner	Ekskl. moms og afgifter
A120612001	3	3	110	740x715x2085	12.802,00

Kompressoraggregat D181106110	Luftkølet Max afstand 8 m	Vægt	Dimensioner	Ekskl. moms og afgifter
		25	430x450x300	Indhent tilbud

Ei-tilslutning	230 / 50Hz
Optagen effekt	328 W - 1,8 A
Kølekapacitet	368 W*
Kølemiddel	R404a
*Ford. -10°C kondens. 54,4°C	

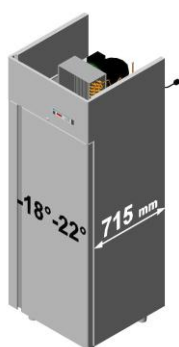
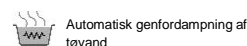
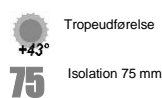

					Pris i DKK
Indbygget kompressor A60/1BE	Hylde 53x53	Hyldevinkler	Vægt	Dimensioner	Ekskl. moms og afgifter
A120606001	3	3	130	740x715x2085	16.232,00

					Pris i DKK
For separat kompressor A60/1BER	Hylde 53x53	Hyldevinkler	Vægt	Dimensioner	Ekskl. moms og afgifter
A120616001	3	3	120	740x715x2085	14.321,00

Kompressoraggregat D182120410	Luftkølet Max afstand 8 m	Vægt	Dimensioner	Ekskl. moms og afgifter
		30	430x450x300	Indhent tilbud

Ei-tilslutning	230 / 50Hz
Optagen effekt	328 W - 1,8 A
Kølekapacitet	368 W*
Kølemiddel	R404a
*Ford. -23,3°C kondens. 54,4°C	

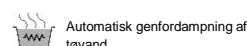
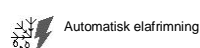
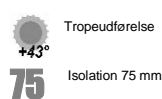

Catering

Skabe

Smart 700 liters GN2/1

Dybde 815 mm



Indbygget kompressor A70/1NE A120701001	Hylder GN 2/1 3	Hyldevinkler 3	Vægt 125	Dimensioner 740x815x2085	Pris i DKK Ekskl. moms og afgifter 13.562,00
--	--------------------	-------------------	-------------	-----------------------------	---

For separat kompressor A70/1NER A120711001	Hylder GN 2/1 3	Hyldevinkler 3	Vægt 115	Dimensioner 740x815x2085	Pris i DKK Ekskl. moms og afgifter 12.541,00
---	--------------------	-------------------	-------------	-----------------------------	---

Kompressoraggregat D181106110	Luftkølet Max afstand 8 m	Vægt 25	Dimensioner 430x450x300	Ekskl. moms og afgifter Indhent tilbud
---	------------------------------	------------	----------------------------	--

El-tilslutning	230 / 50Hz
Optagen effekt	328 W - 1,8 A
Kølekapacitet	368 W*
Kølemiddel	R404a
*Ford. -10°C kondens. 54,4°C	

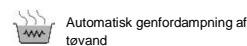
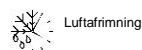

Indbygget kompressor A70/1ME A120702001	Hylder GN 2/1 3	Hyldevinkler 3	Vægt 125	Dimensioner 740x815x2085	Pris i DKK Ekskl. moms og afgifter 13.941,00
--	--------------------	-------------------	-------------	-----------------------------	---

For separat kompressor A70/1MER A120712001	Hylder GN 2/1 3	Hyldevinkler 3	Vægt 115	Dimensioner 740x815x2085	Pris i DKK Ekskl. moms og afgifter 12.921,00
---	--------------------	-------------------	-------------	-----------------------------	---

Kompressoraggregat D181106110	Luftkølet Max afstand 8 m	Vægt 25	Dimensioner 430x450x300	Ekskl. moms og afgifter Indhent tilbud
---	------------------------------	------------	----------------------------	--

El-tilslutning	230 / 50Hz
Optagen effekt	328 W - 1,8 A
Kølekapacitet	368 W*
Kølemiddel	R404a
*Ford. -10°C kondens. 54,4°C	

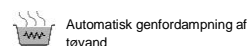

Indbygget kompressor A70/1BE A120706001	Hylder GN 2/1 3	Hyldevinkler 3	Vægt 135	Dimensioner 740x815x2085	Pris i DKK Ekskl. moms og afgifter 16.373,00
--	--------------------	-------------------	-------------	-----------------------------	---

For separat kompressor A70/1BER A120716001	Hylder GN 2/1 3	Hyldevinkler 3	Vægt 125	Dimensioner 740x815x2085	Pris i DKK Ekskl. moms og afgifter 14.463,00
---	--------------------	-------------------	-------------	-----------------------------	---

Kompressoraggregat D182120410	Luftkølet Max afstand 8 m	Vægt 30	Dimensioner 430x450x300	Ekskl. moms og afgifter Indhent tilbud
---	------------------------------	------------	----------------------------	--

El-tilslutning	230 / 50Hz
Optagen effekt	854 W - 4,8 A
Kølekapacitet	782 W*
Kølemiddel	R404a
*Ford. -23,3°C kondens. 54,4°C	

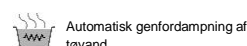
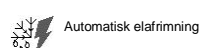

Catering

Skabe

Smart 1200 liters

Dybde 715 mm

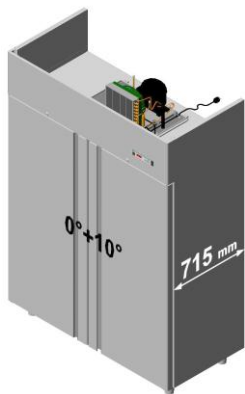

					Pris i DKK
Indbygget kompressor A120/2NE A121201002	Hylder 53x53 6	Hylddevinkler 6	Vægt 180	Dimensioner 1480x715x2085	Ekskl. moms og afgifter 18.448,00

					Pris i DKK
For separat kompressor A120/2NER A121211002	Hylder 53x53 6	Hylddevinkler 6	Vægt 170	Dimensioner 1480x715x2085	Ekskl. moms og afgifter 17.173,00

Kompressoraggregat D181108910	Luftkølet Max afstand 8 m	Vægt 25	Dimensioner 430x450x300	Ekskl. moms og afgifter Indhent tilbud
---	------------------------------	------------	----------------------------	--

Ei-tilslutning	230 / 50Hz
Optagen effekt	653 W - 3,6 A
Kølekapacitet	668 W*
Kølemiddel	R404a

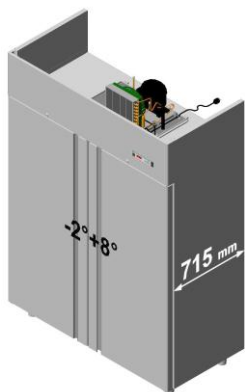
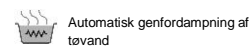

					Pris i DKK
Indbygget kompressor A120/2ME A121202002	Hylder 53x53 6	Hylddevinkler 6	Vægt 180	Dimensioner 1480x715x2085	Ekskl. moms og afgifter 18.867,00

					Pris i DKK
For separat kompressor A120/2MER A121212002	Hylder 53x53 6	Hylddevinkler 6	Vægt 170	Dimensioner 1480x715x2085	Ekskl. moms og afgifter 17.592,00

Kompressoraggregat D181108910	Luftkølet Max afstand 8 m	Vægt 25	Dimensioner 430x450x300	Ekskl. moms og afgifter Indhent tilbud
---	------------------------------	------------	----------------------------	--

Ei-tilslutning	230 / 50Hz
Optagen effekt	653 W - 3,6 A
Kølekapacitet	668 W*
Kølemiddel	R404a

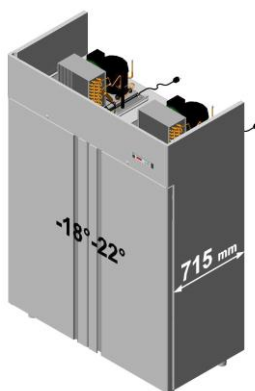
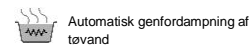
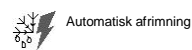

					Pris i DKK
Indbygget kompressor A120/2BE A121206002	Hylder 53x53 6	Hylddevinkler 6	Vægt 190	Dimensioner 1480x715x2085	Ekskl. moms og afgifter 25.539,00

					Pris i DKK
For separat kompressor A120/2BER A121216002	Hylder 53x53 6	Hylddevinkler 6	Vægt 180	Dimensioner 1480x715x2085	Ekskl. moms og afgifter 22.989,00

Kompressoraggregat A+B	Luftkølet Max afstand 8 m	Dimensioner 430x450x300	Indhent tilbud	Indhent tilbud
----------------------------------	------------------------------	----------------------------	-----------------------	-----------------------

Ei-tilslutning	230 / 50Hz
Optagen effekt	1708 W - 9,6 A
Kølekapacitet	1564 W*
Kølemiddel	R404a

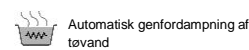
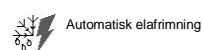

Catering

Skabe

Smart 1400 liters GN2/1

Dybde 815 mm

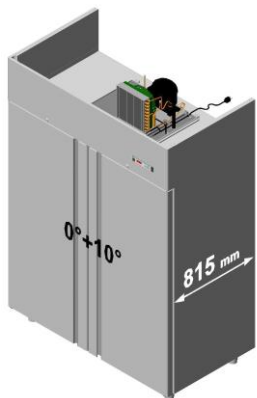

Indbygget kompressor A140/2NE A121401002	Hylde GN 2/1 6	Hyldevinkler 6	Vægt 190	Dimensioner 1480x815x2085	Pris i DKK Ekskl.moms og afgifter 18.743,00
--	-------------------	-------------------	-------------	------------------------------	--

For separat kompressor A140/2NER A121411002	Hylde GN 2/1 6	Hyldevinkler 6	Vægt 180	Dimensioner 1480x815x2085	Pris i DKK Ekskl.moms og afgifter 17.467,00
---	-------------------	-------------------	-------------	------------------------------	--

Kompressoraggregat D181108910	Luftkølet Max afstand 8 m	Vægt 25	Dimensioner 430x450x300	Ekskl.moms og afgifter Indhent tilbud
---	------------------------------	------------	----------------------------	---

Ei-tilslutning	230 / 50Hz
Optagen effekt	653 W - 3,6 A
Kølekapacitet	668 W*
Kølemiddel	R404a
*Ford. -10°C kondens. 54,4°C	

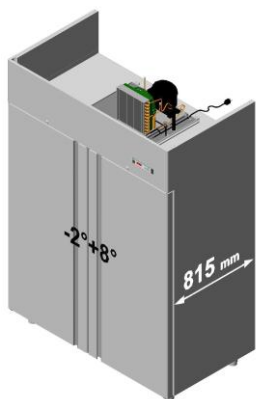
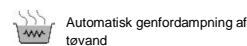
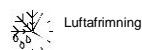

Indbygget kompressor A140/2ME A121402002	Hylde GN 2/1 6	Hyldevinkler 6	Vægt 190	Dimensioner 1480x815x2085	Pris i DKK Ekskl.moms og afgifter 19.179,00
--	-------------------	-------------------	-------------	------------------------------	--

For separat kompressor A140/2MER A121412002	Hylde GN 2/1 6	Hyldevinkler 6	Vægt 180	Dimensioner 1480x815x2085	Pris i DKK Ekskl.moms og afgifter 17.904,00
---	-------------------	-------------------	-------------	------------------------------	--

Kompressoraggregat D181108910	Luftkølet Max afstand 8 m	Vægt 25	Dimensioner 430x450x300	Ekskl.moms og afgifter Indhent tilbud
---	------------------------------	------------	----------------------------	---

Ei-tilslutning	230 / 50Hz
Optagen effekt	653 W - 3,6 A
Kølekapacitet	668 W*
Kølemiddel	R404a
*Ford. -10°C kondens. 54,4°C	

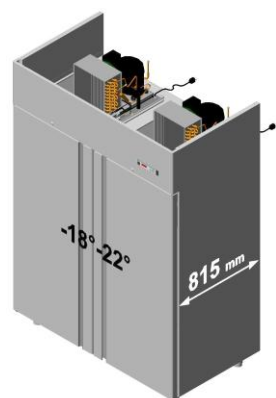
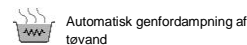
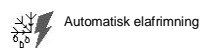





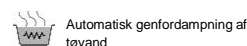

Indbygget kompressor A140/2BE A121406002	Hylde GN 2/1 6	Hyldevinkler 6	Vægt 200	Dimensioner 1480x815x2085	Pris i DKK Ekskl.moms og afgifter 25.851,00
--	-------------------	-------------------	-------------	------------------------------	--

For separat kompressor A140/2BER A121416002	Hylde GN 2/1 6	Hyldevinkler 6	Vægt 190	Dimensioner 1480x815x2085	Pris i DKK Ekskl.moms og afgifter 23.300,00
---	-------------------	-------------------	-------------	------------------------------	--

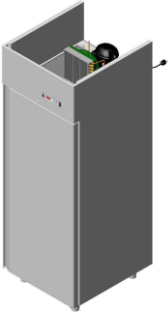
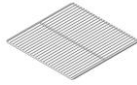
Kompressoraggregat A+B	Luftkølet Max afstand 8 m	Dimensioner 430x450x300	Indhent tilbud	Indhent tilbud
----------------------------------	------------------------------	----------------------------	-----------------------	-----------------------

Ei-tilslutning	230 / 50Hz
Optagen effekt	1708 W - 9,6 A
Kølekapacitet	1564 W*
Kølemiddel	R404a
*Ford. -23,3°C kondens. 54,4°C	



>Produkt	>>Type	>>>Varenummer	>>>Varenummer
 <p>Smart Cabinets</p>	600/1200 lt	O223530530 Plastik coated trådhyld 53x53	O121150520 Rustfri hyldbærere U-profiler, sæt af 2 stk. C – 505 mm
		 <p>Pris i DKK (ekskl. moms) 210,00</p>	 <p>Pris i DKK (ekskl. moms) 210,00</p>
	>>Type	>>>Varenummer	>>>Varenummer
	700/1400 lt	O221650530 Plastik coated trådhyld GN2/1	O121160520 Rustfri hyldbærere U-profiler, sæt af 2 stk. C – 605 mm
		 <p>Pris i DKK (ekskl. moms) 210,00</p>	 <p>Pris i DKK (ekskl. moms) 210,00</p>
	>>Type	>>>Varenummer	>>>Varenummer
	600/700/1200/1400 lt	O820700020 1 dør O821400020 2 dør Lys	O444000020 Rustfrit hjulsæt (sving og låsbare)
		 <p>Pris i DKK (ekskl. moms) 448,00 1 dør 671,00 2 dør</p>	 <p>Pris i DKK (ekskl. moms) 1.641,00</p>

EGENSKABER

Udvendig/indvendig i rustfrit AISI 304 stål

Isolationstykkelse 75 mm

Afrundede hjørner

Højdejusterbare ben (100-150 mm) i rustfrit AISI 304 stål

Selvlukkende vendbare døre, der kan åbnes 105°

Ergonomisk greb i fuld højde i rustfri stål

Magnet tætningslister – nemme at rengøre og udskifte

Dørlås

Aftagelige hyldevanger og hyldevinkler i rustfrit AISI 304 stål

Korrosionsbestandige rilsan hylder GN2/1. Option: Rustfri hylder

Konstruerede for drift ved omgivelsestemperaturer på op til +43° C

Ventileret kulde

Coated fordampere (cataphoresis) for at modvirke tæring

Fuldt udskifteligt kølesystem

Automatisk afrimning (styret af føler)

Genfordampning af tøvand

Elektronisk styring

Lys



Master 350 liter



Side 16

Master 500 liter



Side 17

Master 600 liter



Side 18

Master 650 liter



Side 19

Master 700 liter



Side 20

Master 1200 liter



Side 21

Master 1400 liter



Side 22

Master Fisk 350 liter



Side 23

Master Fisk 700 liter



Side 24

Master Fisk 1400 liter



Side 25

Master Combi 700 liter



Master Combi 1400 liter



Dybde 715 mm

350 liter

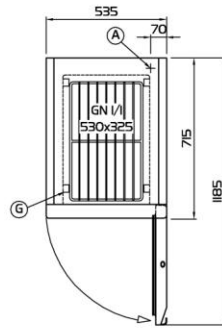
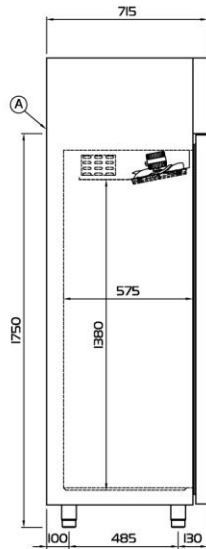
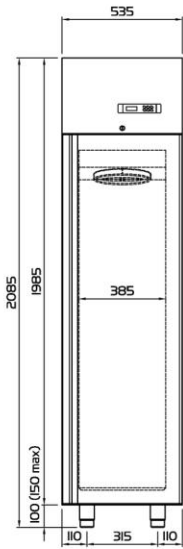

(A) POWER SUPPLY CABLE OUTLET

(G) RACKS PITCH

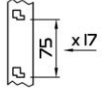

500 liter

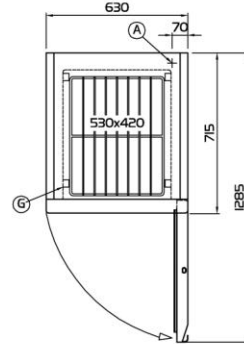
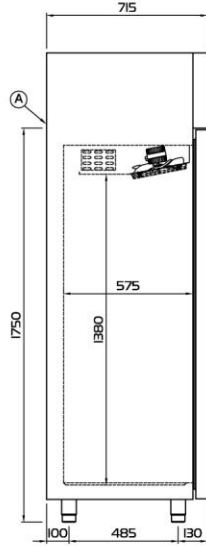
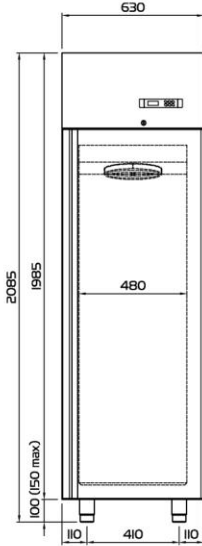

600 liter

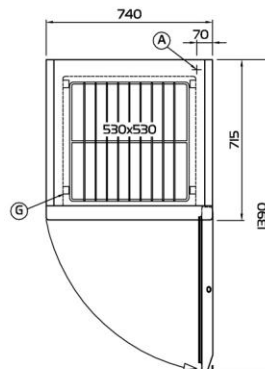
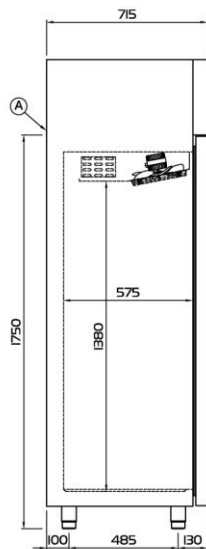
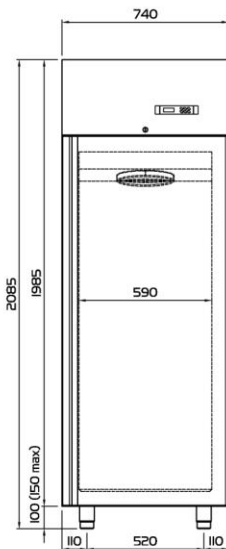

Dybde 715 mm

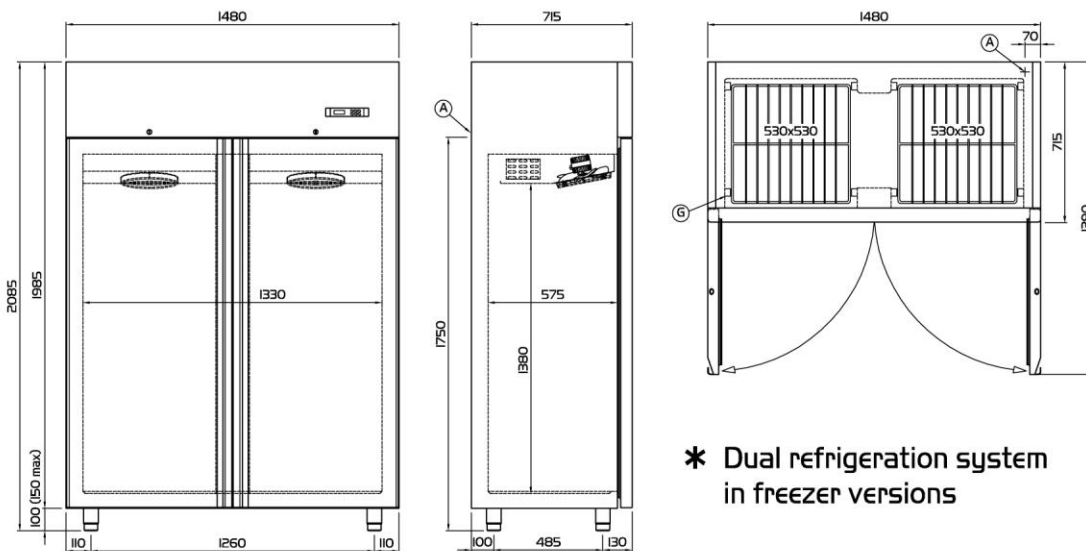
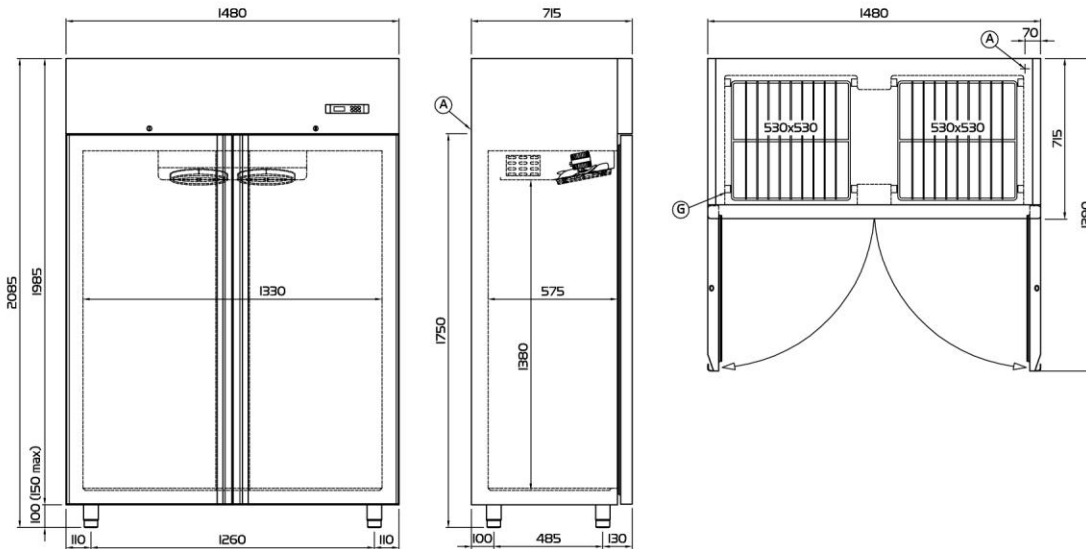
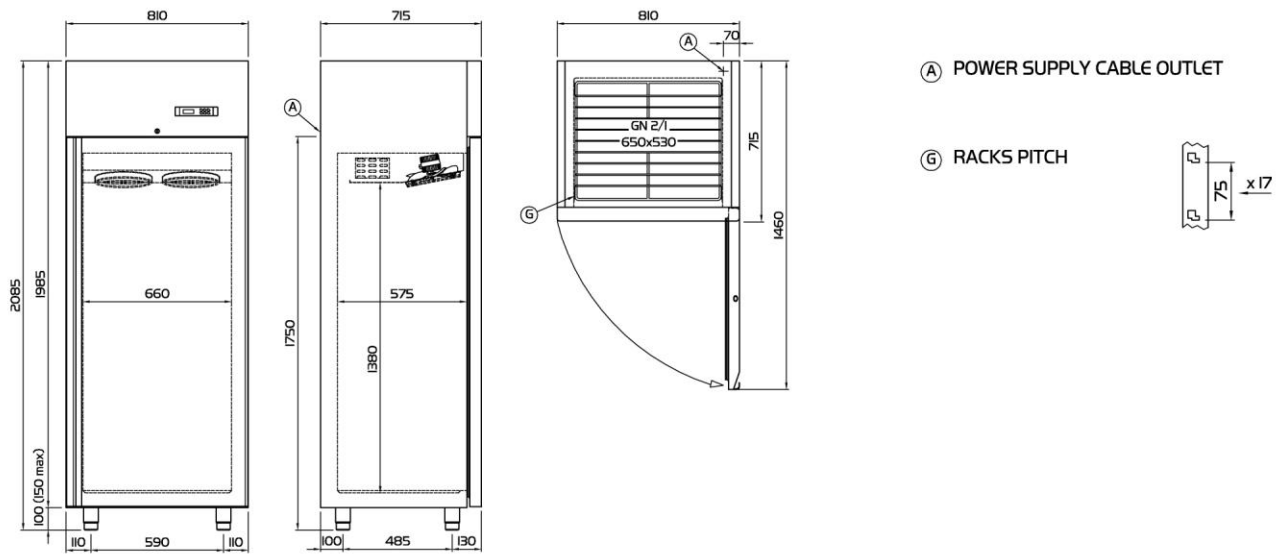

650 liter

1200 liter

1200 liter fryser

Dyde 815 mm

700 liter

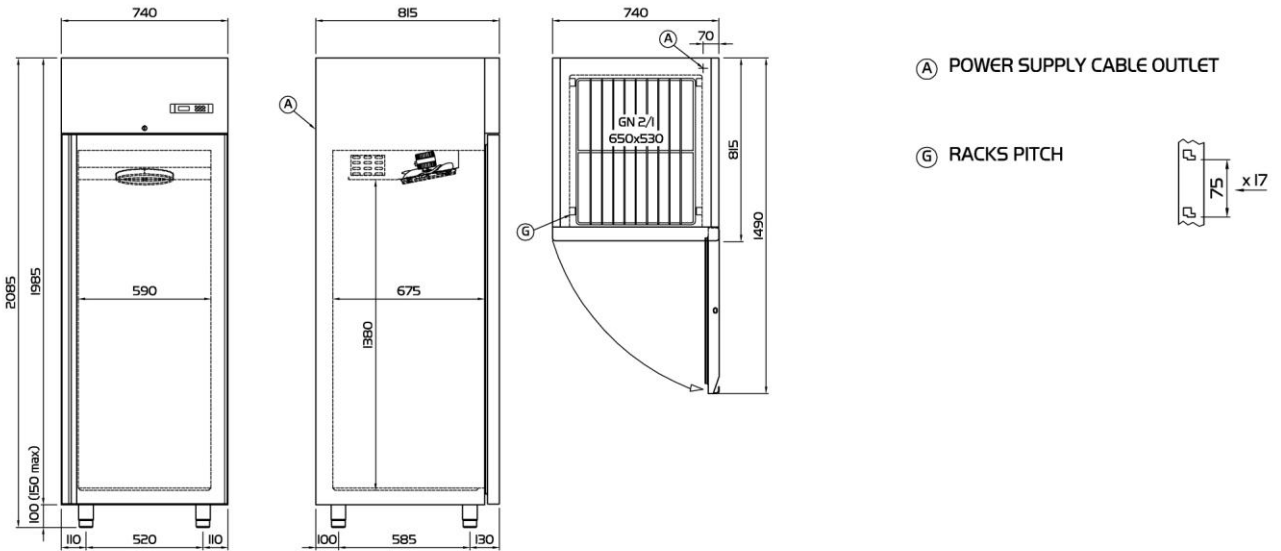

1400 liter

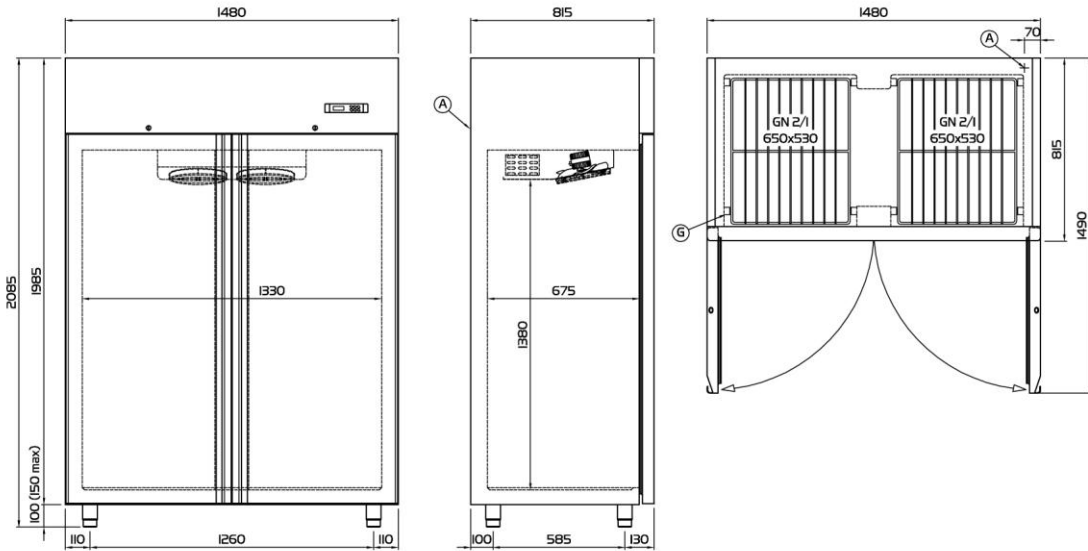

1400 liter fryser

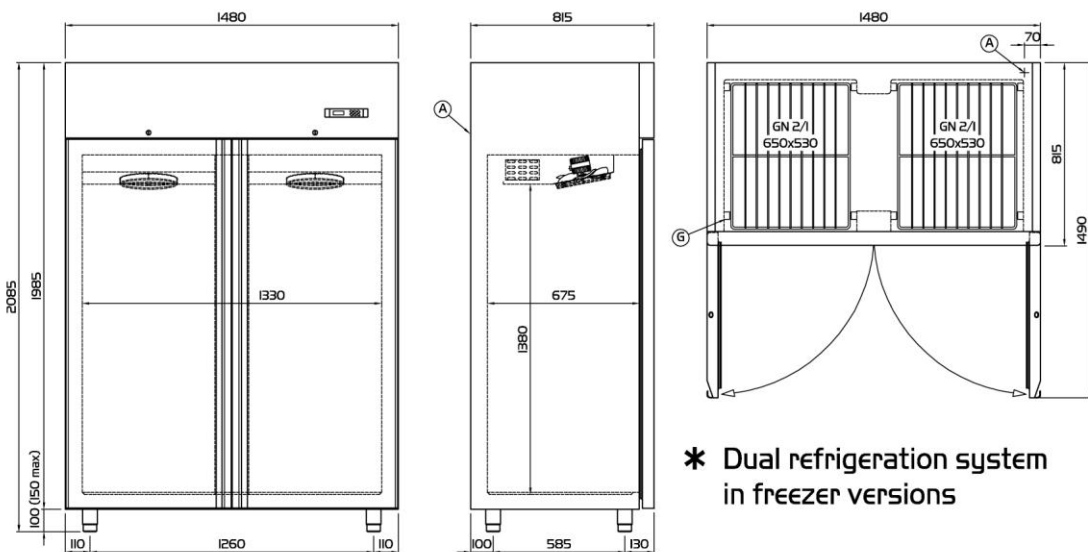

* Dual refrigeration system in freezer versions

Dybde 715-815 mm

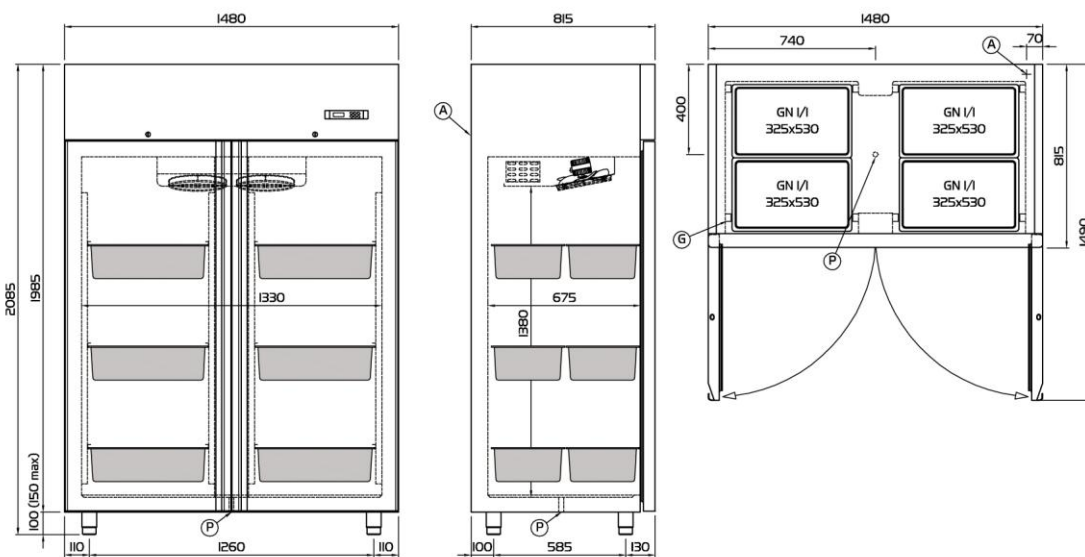
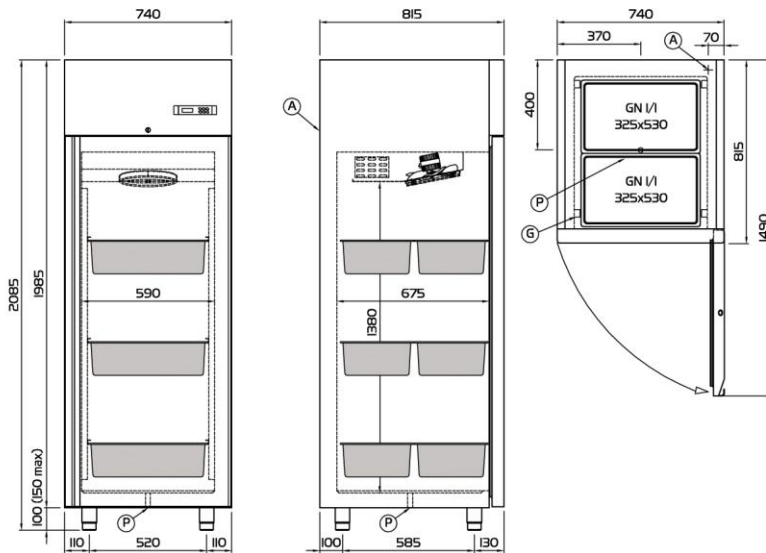
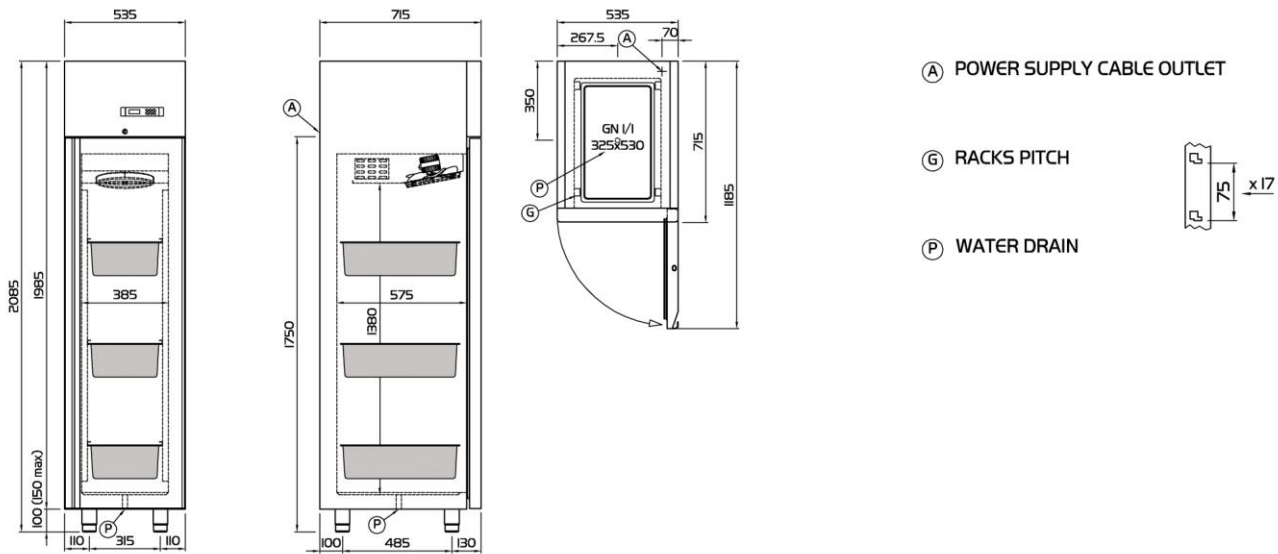

350 liter

700 liter

1400 liter

Dybde 815 mm

Combi 700 liter 2T

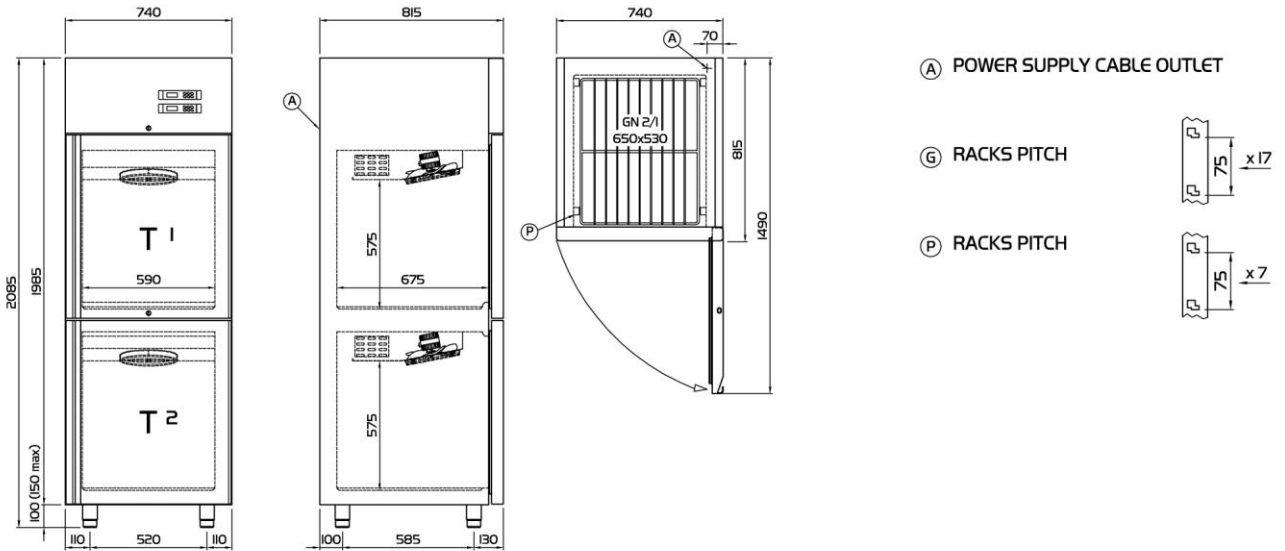

Combi 1400 liter 2T

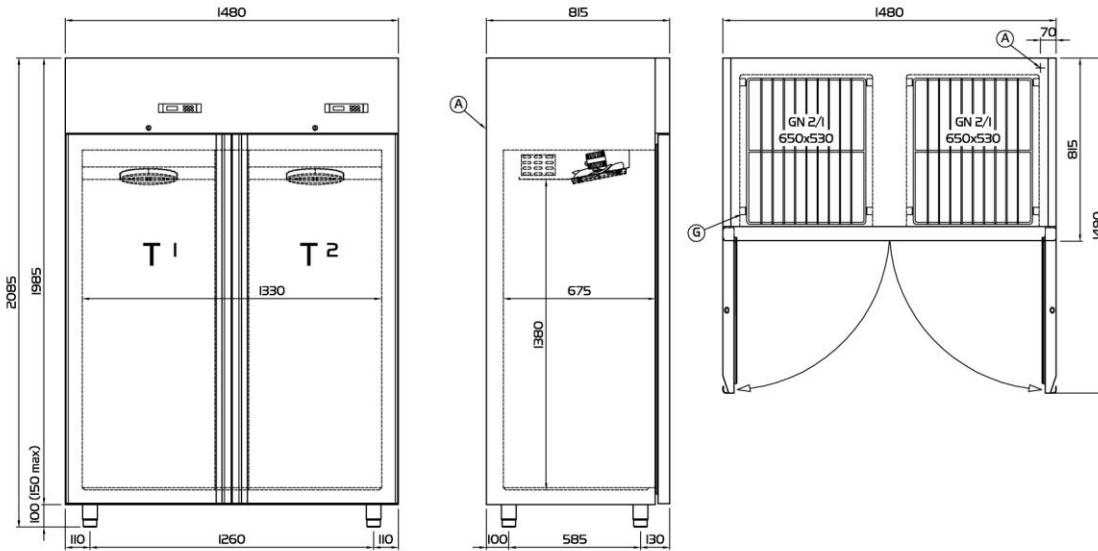

Combi 1400 liter 3T

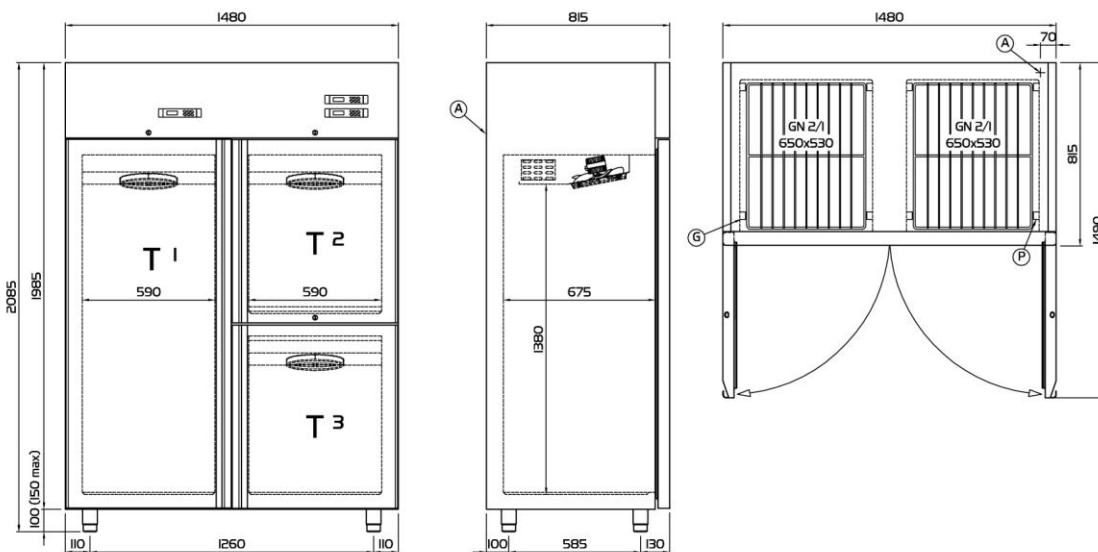

Catering

Skabe

Master 350 liter GN1/1

Dybde 715 mm



					Pris i DKK
Indbygget kompressor A30/1N A140301001	Hylde GN1/1 3	Hyldevinkler 3	Vægt 100	Dimensioner 535x715x2085	Ekskl. moms og afgifter 14.467,00

					Pris i DKK
For separat kompressor A30/1NR A140311001	Hylde GN 1/1 3	Hyldevinkler 3	Vægt 90	Dimensioner 535x715x2085	Ekskl. moms og afgifter 13.608,00

Kompressoraggregat D181106110	Luftkølet Max afstand 8 m	Vægt 25	Dimensioner 430x450x300	Ekskl. moms og afgifter Indhent tilbud
---	------------------------------	------------	----------------------------	--

El-tilslutning	230 / 50Hz
Optagen effekt	328 W - 1,8 A
Kølekapacitet	368 W*
Kølemiddel	R404a
*Ford. -10°C kondens. 54,4°C	

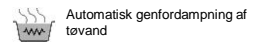
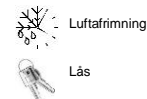
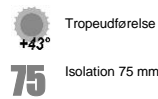

					Pris i DKK
Indbygget kompressor A30/1M A140302001	Hylde GN1/1 3	Hyldevinkler 3	Vægt 100	Dimensioner 535x715x2085	Ekskl. moms og afgifter 14.827,00

					Pris i DKK
For separat kompressor A30/1MR A140312001	Hylde GN 1/1 3	Hyldevinkler 3	Vægt 90	Dimensioner 535x715x2085	Ekskl. moms og afgifter 13.968,00

Kompressoraggregat D181106110	Luftkølet Max afstand 8 m	Vægt 25	Dimensioner 430x450x300	Ekskl. moms og afgifter Indhent tilbud
---	------------------------------	------------	----------------------------	--

El-tilslutning	230 / 50Hz
Optagen effekt	328 W - 1,8 A
Kølekapacitet	368 W*
Kølemiddel	R404a
*Ford. -10°C kondens. 54,4°C	

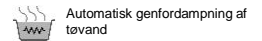
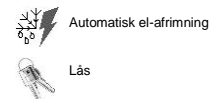
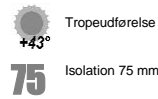

					Pris i DKK
Indbygget kompressor A30/1MV A140302006	Hylde GN1/1 3	Hyldevinkler 3	Vægt 110	Dimensioner 535x715x2085	Ekskl. moms og afgifter 17.566,00

					Pris i DKK
For separat kompressor A30/1MRV A140312006	Hylde GN 1/1 3	Hyldevinkler 3	Vægt 100	Dimensioner 535x715x2085	Ekskl. moms og afgifter 13.968,00

Kompressoraggregat D181106110	Luftkølet Max afstand 8 m	Vægt 25	Dimensioner 430x450x300	Ekskl. moms og afgifter Indhent tilbud
---	------------------------------	------------	----------------------------	--

El-tilslutning	230 / 50Hz
Optagen effekt	328 W - 1,8 A
Kølekapacitet	368 W*
Kølemiddel	R404a
*Ford. -10°C kondens. 54,4°C	

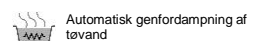
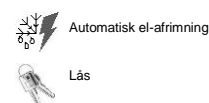
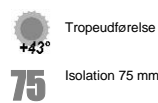

Catering

Skabe

Master 500 liter

Dybde 715 mm

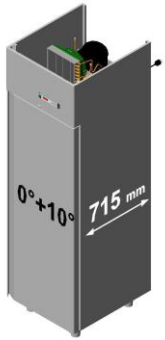

					Pris i DKK
Indbygget kompressor A50/1N A140501001	Hylder 43*53 3	Hyldevinkler 3	Vægt 110	Dimensioner 630x715x2085	Ekskl. moms og afgifter 14.914,00

					Pris i DKK
For separat kompressor A50/1NR A140511001	Hylder 43*53 3	Hyldevinkler 3	Vægt 100	Dimensioner 630x715x2085	Ekskl. moms og afgifter 14.055,00

Kompressoraggregat D181106110	Luftkølet Max afstand 8 m	Vægt 25	Dimensioner 430x450x300	Ekskl. moms og afgifter Indhent tilbud
---	------------------------------	------------	----------------------------	--

El-tilslutning	230 / 50Hz
Optagen effekt	328 W - 1,8 A
Kølekapacitet	368 W*
Kølemiddel	R404a
*Ford. -10°C kondens. 54,4°C	



					Pris i DKK
Indbygget kompressor A50/1M A140502001	Hylder 43*53 3	Hyldevinkler 3	Vægt 110	Dimensioner 630x715x2085	Ekskl. moms og afgifter 15.285,00

					Pris i DKK
For separat kompressor A50/1MR A140512001	Hylder 43*53 3	Hyldevinkler 3	Vægt 100	Dimensioner 630x715x2085	Ekskl. moms og afgifter 14.426,00

Kompressoraggregat D181106110	Luftkølet Max afstand 8 m	Vægt 25	Dimensioner 430x450x300	Ekskl. moms og afgifter Indhent tilbud
---	------------------------------	------------	----------------------------	--

El-tilslutning	230 / 50Hz
Optagen effekt	328 W - 1,8 A
Kølekapacitet	368 W*
Kølemiddel	R404a
*Ford. -10°C kondens. 54,4°C	



					Pris i DKK
Indbygget kompressor A50/1MV A140502006	Hylder 43*53 3	Hyldevinkler 3	Vægt 120	Dimensioner 630x715x2085	Ekskl. moms og afgifter 18.077,00

					Pris i DKK
For separat kompressor A50/1MRV A140512006	Hylder 43*53 3	Hyldevinkler 3	Vægt 110	Dimensioner 630x715x2085	Ekskl. moms og afgifter 17.218,00

Kompressoraggregat D181106110	Luftkølet Max distance 8 m	Vægt 25	Dimensioner 430x450x300	Ekskl. moms og afgifter Indhent tilbud
---	-------------------------------	------------	----------------------------	--

El-tilslutning	230 / 50Hz
Optagen effekt	328 W - 1,8 A
Kølekapacitet	368 W*
Kølemiddel	R404a
*Ford. -10°C kondens. 54,4°C	



Catering

Skabe

Master 600 liter

Dybde 715 mm

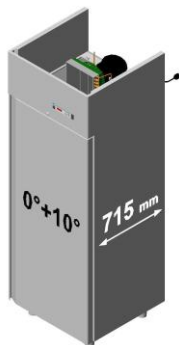

					Pris i DKK
Indbygget kompressor A60/1N A140601001	Hylder 53*53 3	Hylddevinkler 3	Vægt 120	Dimensioner 740x715x2085	
Ekskl. moms og afgifter 15.032,00					

					Pris i DKK
For separat kompressor A60/1NR A140611001	Hylder 53*53 3	Hylddevinkler 3	Vægt 110	Dimensioner 740x715x2085	
Ekskl. moms og afgifter 14.066,00					

Kompressoraggregat D181106110	Luftkølet Max afstand 8 m	Vægt 25	Dimensioner 430x450x300	Ekskl. moms og afgifter Indhent tilbud
---	------------------------------	------------	----------------------------	--

El-tilslutning	230 / 50Hz
Optagen effekt	328 W - 1,8 A
Kølekapacitet	368 W*
Kølemiddel	R404a
*Ford. -10°C kondens. 54,4°C	

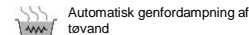
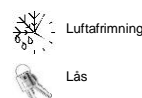

					Pris i DKK
Indbygget kompressor A60/1M A140602001	Hylder 53*53 3	Hylddevinkler 3	Vægt 120	Dimensioner 740x715x2085	
Ekskl. moms og afgifter 15.408,00					

					Pris i DKK
For separat kompressor A60/1MR A140612001	Hylder 53*53 3	Hylddevinkler 3	Vægt 110	Dimensioner 740x715x2085	
Ekskl. moms og afgifter 14.442,00					

Kompressoraggregat D181106110	Luftkølet Max afstand 8 m	Vægt 25	Dimensioner 430x450x300	Ekskl. moms og afgifter Indhent tilbud
---	------------------------------	------------	----------------------------	--

El-tilslutning	230 / 50Hz
Optagen effekt	328 W - 1,8 A
Kølekapacitet	368 W*
Kølemiddel	R404a
*Ford. -10°C kondens. 54,4°C	

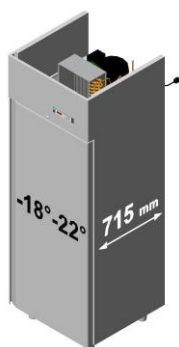
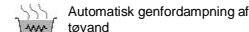
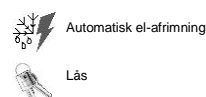

					Pris i DKK
Indbygget kompressor A60/1B A140606001	Hylder 53*53 3	Hylddevinkler 3	Vægt 130	Dimensioner 740x715x2085	
Ekskl. moms og afgifter 17.798,00					

					Pris i DKK
For separat kompressor A60/1BR A140616001	Hylder 53*53 3	Hylddevinkler 3	Vægt 120	Dimensioner 740x715x2085	
Ekskl. moms og afgifter 16.026,00					

Kompressoraggregat D182120410	Luftkølet Max afstand 8 m	Vægt 30	Dimensioner 430x450x300	Ekskl. moms og afgifter Indhent tilbud
---	------------------------------	------------	----------------------------	--

El-tilslutning	230 / 50Hz
Optagen effekt	854 W - 4,8 A
Kølekapacitet	782 W*
Kølemiddel	R404a
*Ford. -23,3°C kondens. 54,4°C	

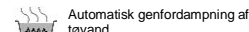
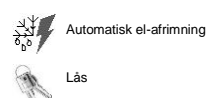

Catering

Skabe

Master 600 liter

Dybde 715 mm

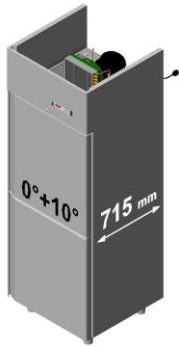

					Pris i DKK
Indbygget kompressor A60/2N A140601002	Hylde 53*53 3	Hyldevinkler 3	Vægt 120	Dimensioner 740x715x2085	
Ekskl. moms og afgifter 15.989,00					

					Pris i DKK
For separat kompressor A60/2NR A140611002	Hylde 53*53 3	Hyldevinkler 3	Vægt 110	Dimensioner 740x715x2085	
Ekskl. moms og afgifter 15.016,00					

Kompressoraggregat D181106110	Luftkølet Max afstand 8 m	Vægt 25	Dimensioner 430x450x300	Ekskl. moms og afgifter Indhent tilbud
---	------------------------------	------------	----------------------------	--

Ei-tilslutning	230 / 50Hz
Optagen effekt	328 W - 1,8 A
Kølekapacitet	368 W*
Kølemiddel	R404a
*Ford. -10°C kondens. 54,4°C	

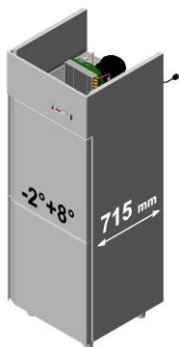
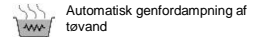
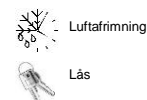
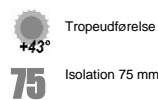

					Pris i DKK
Indbygget kompressor A60/2M A140602002	Hylde 53*53 3	Hyldevinkler 3	Vægt 120	Dimensioner 740x715x2085	
Ekskl. moms og afgifter 16.397,00					

					Pris i DKK
For separat kompressor A60/2MR A140612002	Hylde 53*53 3	Hyldevinkler 3	Vægt 110	Dimensioner 740x715x2085	
Ekskl. moms og afgifter 15.430,00					

Kompressoraggregat D181106110	Luftkølet Max afstand 8 m	Vægt 25	Dimensioner 430x450x300	Ekskl. moms og afgifter Indhent tilbud
---	------------------------------	------------	----------------------------	--

Ei-tilslutning	230 / 50Hz
Optagen effekt	328 W - 1,8 A
Kølekapacitet	368 W*
Kølemiddel	R404a
*Ford. -10°C kondens. 54,4°C	

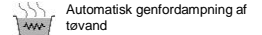
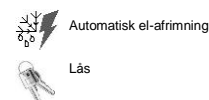
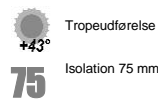

					Pris i DKK
Indbygget kompressor A60/2B A140606002	Hylde 53*53 3	Hyldevinkler 3	Vægt 130	Dimensioner 740x715x2085	
Ekskl. moms og afgifter 18.937,00					

					Pris i DKK
For separat kompressor A60/2BR A140616002	Hylde 53*53 3	Hyldevinkler 3	Vægt 120	Dimensioner 740x715x2085	
Ekskl. moms og afgifter 17.164,00					

Kompressoraggregat D182120410	Luftkølet Max distance 8 m	Vægt 30	Dimensioner 430x450x300	Ekskl. moms og afgifter Indhent tilbud
---	-------------------------------	------------	----------------------------	--

Ei-tilslutning	230 / 50Hz
Optagen effekt	854 W - 4,8 A
Kølekapacitet	782 W*
Kølemiddel	R404a
*Ford. -23,3°C kondens. 54,4°C	

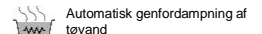
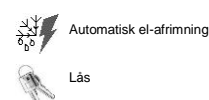
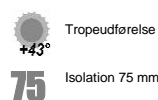

Catering

Skabe

Master 600 liter

Dybde 715 mm



					Pris i DKK
Indbygget kompressor A60/1NV A140601006	Hylde 53*53 3	Hyldevinkler 3	Vægt 130	Dimensioner 740x715x2085	Ekskl. moms og afgifter 17.841,00

					Pris i DKK
For separat kompressor A60/1NRV A140611006	Hylde 53*53 3	Hyldevinkler 3	Vægt 120	Dimensioner 740x715x2085	Ekskl. moms og afgifter 16.874,00

Kompressoraggregat D181106110	Luftkølet Max afstand 8 m	Vægt 25	Dimensioner 430x450x300	Ekskl. moms og afgifter Indhent tilbud
---	------------------------------	------------	----------------------------	--

El-tilslutning	230 / 50Hz
Optagen effekt	486 W - 2,6 A
Kølekapacitet	519 W*
Kølemiddel	R404a
*Ford. -10°C kondens. 54,4°C	

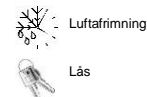

					Pris i DKK
Indbygget kompressor A60/1MV A140602006	Hylde 53*53 3	Hyldevinkler 3	Vægt 130	Dimensioner 740x715x2085	Ekskl. moms og afgifter 18.228,00

					Pris i DKK
For separat kompressor A60/1MRV A140612006	Hylde 53*53 3	Hyldevinkler 3	Vægt 120	Dimensioner 740x715x2085	Ekskl. moms og afgifter 17.261,00

Kompressoraggregat D181106110	Luftkølet Max afstand 8 m	Vægt 25	Dimensioner 430x450x300	Ekskl. moms og afgifter Indhent tilbud
---	------------------------------	------------	----------------------------	--

El-tilslutning	230 / 50Hz
Optagen effekt	486 W - 2,6 A
Kølekapacitet	519 W*
Kølemiddel	R404a
*Ford. -10°C kondens. 54,4°C	

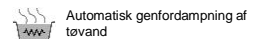
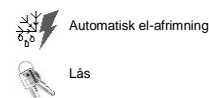
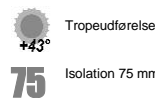

					Pris i DKK
Indbygget kompressor A60/1BV A140606006	Hylde 53*53 3	Hyldevinkler 3	Vægt 140	Dimensioner 740x715x2085	Ekskl. moms og afgifter 21.649,00

					Pris i DKK
For separat kompressor A60/1BRV A140616006	Hylde 53*53 3	Hyldevinkler 3	Vægt 130	Dimensioner 740x715x2085	Ekskl. moms og afgifter 19.876,00

Kompressoraggregat D182120410	Luftkølet Max afstand 8 m	Vægt 30	Dimensioner 430x450x300	Ekskl. moms og afgifter Indhent tilbud
---	------------------------------	------------	----------------------------	--

El-tilslutning	230 / 50Hz
Optagen effekt	1056 W - 5,9 A
Kølekapacitet	935 W*
Kølemiddel	R404a
*Ford. -23,3°C kondens. 54,4°C	

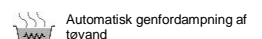
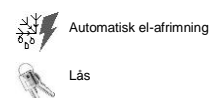

Catering

Skabe

Master 650 liter GN2/1

Dybde 715 mm

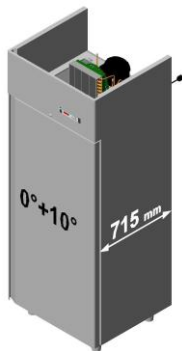

					Pris i DKK
Indbygget kompressor A80/1NU A140801001	Hylde GN2/1 3	Hyldevinkler 3	Vægt 125	Dimensioner 810x715x2085	
Ekskl. moms og afgifter 16.176,00					

					Pris i DKK
For separat kompressor A80/1NUR A140811001	Hylde GN2/1 3	Hyldevinkler 3	Vægt 115	Dimensioner 810x715x2085	
Ekskl. moms og afgifter 15.129,00					

Kompressoraggregat D181106110	Luftkølet Max afstand 8 m	Vægt 25	Dimensioner 430x450x300	Ekskl. moms og afgifter Indhent tilbud
---	------------------------------	------------	----------------------------	--

El-tilslutning	230 / 50Hz
Optagen effekt	653 W - 3,6 A
Kølekapacitet	668 W*
Kølemiddel	R404a
*Ford. -10°C kondens. 54,4°C	

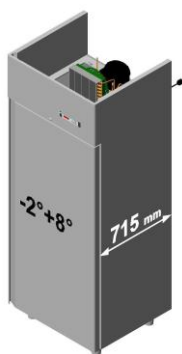
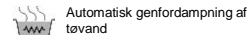
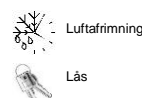

					Pris i DKK
Indbygget kompressor A80/1MU A140802001	Hylde GN2/1 3	Hyldevinkler 3	Vægt 125	Dimensioner 810x715x2085	
Ekskl. moms og afgifter 16.558,00					

					Pris i DKK
For separat kompressor A80/1MUR A140812001	Hylde GN2/1 3	Hyldevinkler 3	Vægt 115	Dimensioner 810x715x2085	
Ekskl. moms og afgifter 15.543,00					

Kompressoraggregat D181106110	Luftkølet Max afstand 8 m	Vægt 25	Dimensioner 430x450x300	Ekskl. moms og afgifter Indhent tilbud
---	------------------------------	------------	----------------------------	--

El-tilslutning	230 / 50Hz
Optagen effekt	653 W - 3,6 A
Kølekapacitet	668 W*
Kølemiddel	R404a
*Ford. -10°C kondens. 54,4°C	

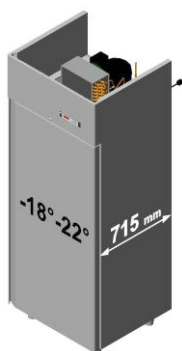
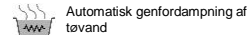
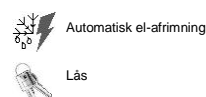

					Pris i DKK
Indbygget kompressor A80/1BU A140806001	Hylde GN2/1 3	Hyldevinkler 3	Vægt 135	Dimensioner 810x715x2085	
Ekskl. moms og afgifter 19.914,00					

					Pris i DKK
For separat kompressor A80/1BUR A140816001	Hylde GN2/1 3	Hyldevinkler 3	Vægt 125	Dimensioner 810x715x2085	
Ekskl. moms og afgifter 17.256,00					

Kompressoraggregat D182120410	Luftkølet Max afstand 8 m	Vægt 30	Dimensioner 430x450x300	Ekskl. moms og afgifter Indhent tilbud
---	------------------------------	------------	----------------------------	--

El-tilslutning	230 / 50Hz
Optagen effekt	1066 W - 5,9 A
Kølekapacitet	935 W*
Kølemiddel	R404a
*Ford. -23,3°C kondens. 54,4°C	

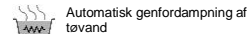
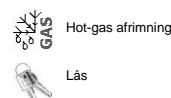
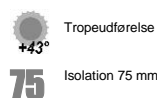

Catering

Skabe

Master 700 liter GN2/1

Dybde 815 mm

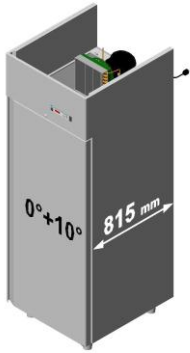

					Pris i DKK
Indbygget kompressor A70/1N A140701001	Hylde GN2/1 3	Hyldevinkler 3	Vægt 125	Dimensioner 740x815x2085	
Ekskl. moms og afgifter 15.489,00					

					Pris i DKK
For separat kompressor A70/1NR A140711001	Hylde GN2/1 3	Hyldevinkler 3	Vægt 115	Dimensioner 740x815x2085	
Ekskl. moms og afgifter 14.522,00					

Kompressoraggregat D181106110	Luftkølet Max afstand 8 m	Vægt 25	Dimensioner 430x450x300	Ekskl. moms og afgifter Indhent tilbud
---	------------------------------	------------	----------------------------	--

El-tilslutning	230 / 50Hz
Optagen effekt	328 W - 1,8 A
Kølekapacitet	368 W*
Kølemiddel	R404a
*Ford. -10°C kondens. 54,4°C	

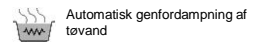
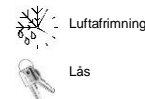
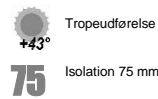

					Pris i DKK
Indbygget kompressor A70/1M A140702001	Hylde GN2/1 3	Hyldevinkler 3	Vægt 125	Dimensioner 740x815x2085	
Ekskl. moms og afgifter 15.881,00					

					Pris i DKK
For separat kompressor A70/1MR A140712001	Hylde GN2/1 3	Hyldevinkler 3	Vægt 115	Dimensioner 740x815x2085	
Ekskl. moms og afgifter 14.914,00					

Kompressoraggregat D181106110	Luftkølet Max afstand 8 m	Vægt 25	Dimensioner 430x450x300	Ekskl. moms og afgifter Indhent tilbud
---	------------------------------	------------	----------------------------	--

El-tilslutning	230 / 50Hz
Optagen effekt	328 W - 1,8 A
Kølekapacitet	368 W*
Kølemiddel	R404a
*Ford. -10°C kondens. 54,4°C	

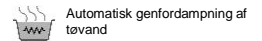
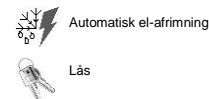
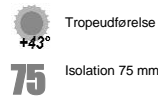

					Pris i DKK
Indbygget kompressor A70/1B A140706001	Hylde GN2/1 3	Hyldevinkler 3	Vægt 135	Dimensioner 740x815x2085	
Ekskl. moms og afgifter 18.314,00					

					Pris i DKK
For separat kompressor A70/1BR A140716001	Hylde GN2/1 3	Hyldevinkler 3	Vægt 125	Dimensioner 740x815x2085	
Ekskl. moms og afgifter 16.595,00					

Kompressoraggregat D182120410	Luftkølet Max afstand 8 m	Vægt 30	Dimensioner 430x450x300	Ekskl. moms og afgifter Indhent tilbud
---	------------------------------	------------	----------------------------	--

El-tilslutning	230 / 50Hz
Optagen effekt	854 W - 4,8 A
Kølekapacitet	782 W*
Kølemiddel	R404a
*Ford. -23,3°C kondens. 54,4°C	

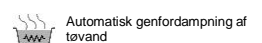
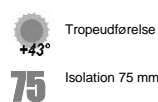

Catering

Skabe

Master 700 liter GN2/1

Dybde 815 mm

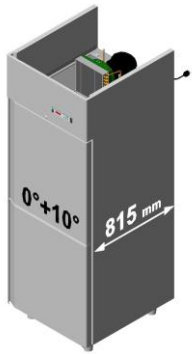

					Pris i DKK
Indbygget kompressor A70/2N	Hylder GN2/1	Hylddevinkler	Vægt	Dimensioner	Ekskl. moms og afgifter
A140701002	3	3	125	740x815x2085	16.466,00

					Pris i DKK
For separat kompressor A70/2NR	Hylder GN2/1	Hylddevinkler	Vægt	Dimensioner	Ekskl. moms og afgifter
A140711002	3	3	115	740x815x2085	15.500,00

Kompressoraggregat	Luftkølet	Vægt	Dimensioner	Ekskl. moms og afgifter
D181106110	Max afstand 8 m	25	430x450x300	Indhent tilbud

El-tilslutning	230 / 50Hz
Optagen effekt	328 W - 1,8 A
Kølekapacitet	368 W*
Kølemiddel	R404a
*Ford. -10°C kondens. 54,4°C	

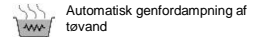
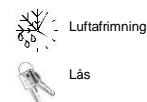
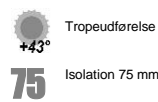

					Pris i DKK
Indbygget kompressor A70/2M	Hylder GN2/1	Hylddevinkler	Vægt	Dimensioner	Ekskl. moms og afgifter
A140702002	3	3	125	740x815x2085	16.891,00

					Pris i DKK
For separat kompressor A70/2MR	Hylder GN2/1	Hylddevinkler	Vægt	Dimensioner	Ekskl. moms og afgifter
A140712002	3	3	115	740x815x2085	15.924,00

Kompressoraggregat	Luftkølet	Vægt	Dimensioner	Ekskl. moms og afgifter
D181106110	Max afstand 8 m	25	430x450x300	Indhent tilbud

El-tilslutning	230 / 50Hz
Optagen effekt	328 W - 1,8 A
Kølekapacitet	368 W*
Kølemiddel	R404a
*Ford. -10°C kondens. 54,4°C	

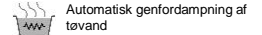
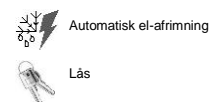
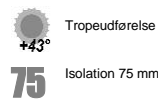

					Pris i DKK
Indbygget kompressor A70/2B	Hylder GN2/1	Hylddevinkler	Vægt	Dimensioner	Ekskl. moms og afgifter
A140706002	3	3	135	740x815x2085	19.484,00

					Pris i DKK
For separat kompressor A70/2BR	Hylder GN2/1	Hylddevinkler	Vægt	Dimensioner	Ekskl. moms og afgifter
A140716002	3	3	125	740x815x2085	17.728,00

Kompressoraggregat	Luftkølet	Vægt	Dimensioner	Ekskl. moms og afgifter
D182120410	Max afstand 8 m	30	430x450x300	Indhent tilbud

El-tilslutning	230 / 50Hz
Optagen effekt	854 W - 4,8 A
Kølekapacitet	782 W*
Kølemiddel	R404a
*Ford. -23,3°C kondens. 54,4°C	

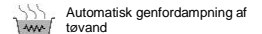
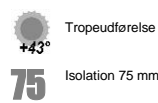

Catering

Skabe

Master 700 liter GN2/1

Dybde 815 mm



					Pris i DKK
Indbygget kompressor A70/1NV	Hylde GN2/1	Hyldevinkler	Vægt	Dimensioner	Ekskl. moms og afgifter
A140701006	3	3	135	740x815x2085	18.373,00

					Pris i DKK
For separat kompressor A70/1NRV	Hylde GN2/1	Hyldevinkler	Vægt	Dimensioner	Ekskl. moms og afgifter
A140711006	3	3	125	740x815x2085	17.406,00

Kompressoraggregat D181106110	Luftkølet Max afstand 8 m	Vægt	Dimensioner	Ekskl. moms og afgifter
		25	430x450x300	Indhent tilbud

El-tilslutning	230 / 50Hz
Optagen effekt	486 W - 2,6 A
Kølekapacitet	519 W*
Kølemiddel	R404a
*Ford. -10°C kondens. 54,4°C	

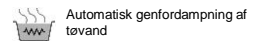
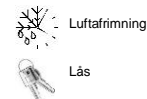
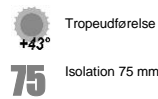

					Pris i DKK
Indbygget kompressor A70/1MV	Hylde GN2/1	Hyldevinkler	Vægt	Dimensioner	Ekskl. moms og afgifter
A140702006	3	3	135	740x815x2085	18.759,00

					Pris i DKK
For separat kompressor A70/1MRV	Hylde GN2/1	Hyldevinkler	Vægt	Dimensioner	Ekskl. moms og afgifter
A140712006	3	3	125	740x815x2085	17.793,00

Kompressoraggregat D181106110	Luftkølet Max afstand 8 m	Vægt	Dimensioner	Ekskl. moms og afgifter
		25	430x450x300	Indhent tilbud

El-tilslutning	230 / 50Hz
Optagen effekt	486 W - 2,6 A
Kølekapacitet	519 W*
Kølemiddel	R404a
*Ford. -10°C kondens. 54,4°C	

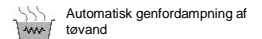
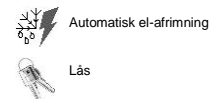
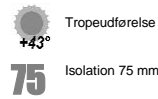

					Pris i DKK
Indbygget kompressor A70/1BV	Hylde GN2/1	Hyldevinkler	Vægt	Dimensioner	Ekskl. moms og afgifter
A140706006	3	3	145	740x815x2085	22.250,00

					Pris i DKK
For separat kompressor A70/1BRV	Hylde GN2/1	Hyldevinkler	Vægt	Dimensioner	Ekskl. moms og afgifter
A140716006	3	3	135	740x815x2085	20.478,00

Kompressoraggregat D182120410	Luftkølet Max afstand 8 m	Vægt	Dimensioner	Ekskl. moms og afgifter
		30	430x450x300	Indhent tilbud

El-tilslutning	230 / 50Hz
Optagen effekt	1056 W - 5,9 A
Kølekapacitet	935 W*
Kølemiddel	R404a
*Ford. -23,3°C kondens. 54,4°C	

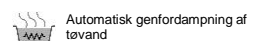
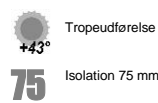

Catering

Skabe

Master 1200 liter

Dybde 715 mm

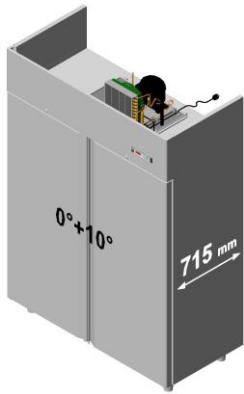

Indbygget kompressor A120/2N A141201002	Hylder 53x53 6	Hyldevinkler 6	Vægt 180	Dimensioner 1480x715x2085	Pris i DKK Ekskl. moms og afgifter 23.805,00
---	-------------------	-------------------	-------------	------------------------------	--

For separat kompressor A120/2NR A141211002	Hylder 53x53 6	Hyldevinkler 6	Vægt 170	Dimensioner 1480x715x2085	Pris i DKK Ekskl. moms og afgifter 22.597,00
--	-------------------	-------------------	-------------	------------------------------	--

Kompressoraggregat D181108910	Luftkølet Max afstand 8 m	Vægt 25	Dimensioner 430x450x300	Ekskl. moms og afgifter Indhent tilbud
---	------------------------------	------------	----------------------------	--

Ei-tilslutning	230 / 50Hz
Optagen effekt	653 W - 3,6 A
Kølekapacitet	668 W*
Kølemiddel	R404a
*Ford. -10°C kondens. 54,4°C	

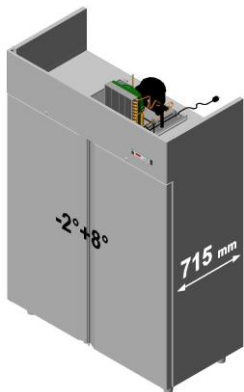
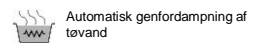
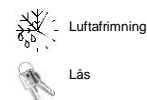
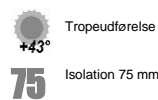

Indbygget kompressor A120/2M A141202002	Hylder 53x53 6	Hyldevinkler 6	Vægt 180	Dimensioner 1480x715x2085	Pris i DKK Ekskl. moms og afgifter 24.197,00
---	-------------------	-------------------	-------------	------------------------------	--

For separat kompressor A120/2MR A141212002	Hylder 53x53 6	Hyldevinkler 6	Vægt 170	Dimensioner 1480x715x2085	Pris i DKK Ekskl. moms og afgifter 22.994,00
--	-------------------	-------------------	-------------	------------------------------	--

Kompressoraggregat D181108910	Luftkølet Max afstand 8 m	Vægt 25	Dimensioner 430x450x300	Ekskl. moms og afgifter Indhent tilbud
---	------------------------------	------------	----------------------------	--

Ei-tilslutning	230 / 50Hz
Optagen effekt	653 W - 3,6 A
Kølekapacitet	668 W*
Kølemiddel	R404a
*Ford. -10°C kondens. 54,4°C	

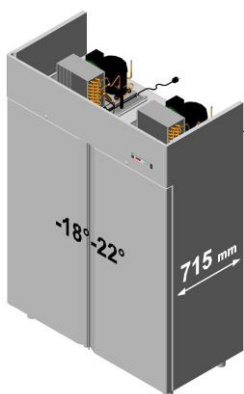
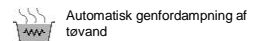
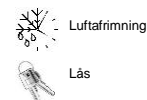
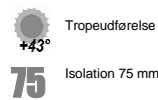

Indbygget kompressor A120/2B A141206002	Hylder 53x53 6	Hyldevinkler 6	Vægt 190	Dimensioner 1480x715x2085	Pris i DKK Ekskl. moms og afgifter 30.018,00
---	-------------------	-------------------	-------------	------------------------------	--

For separat kompressor A120/2BR A141216002	Hylder 53x53 6	Hyldevinkler 6	Vægt 180	Dimensioner 1480x715x2085	Pris i DKK Ekskl. moms og afgifter 27.602,00
--	-------------------	-------------------	-------------	------------------------------	--

Kompressoraggregat A+B	Luftkølet Max afstand 8 m	Dimensioner 430x450x300	Indhent tilbud	Indhent tilbud
----------------------------------	------------------------------	----------------------------	-----------------------	-----------------------

Ei-tilslutning	230 / 50Hz
Optagen effekt	1708 W - 9,6 A
Kølekapacitet	1564 W*
Kølemiddel	R404a
*Ford. -23,3°C kondens. 54,4°C	

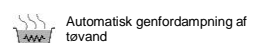
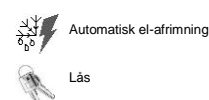

Catering

Skabe

Master 1200 liter

Dybde 715 mm

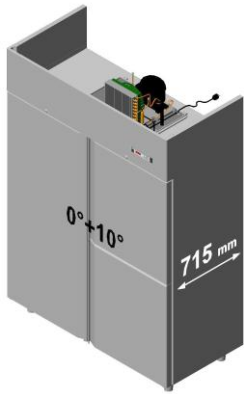

Indbygget kompressor A120/3N A141201003	Hylde 53x53 6	Hyldevinkler 6	Vægt 180	Dimensioner 1480x715x2085	Pris i DKK Ekskl. moms og afgifter 24.734,00
---	------------------	-------------------	-------------	------------------------------	---

For separat kompressor A120/3NR A141211003	Hylde 53x53 6	Hyldevinkler 6	Vægt 170	Dimensioner 1480x715x2085	Pris i DKK Ekskl. moms og afgifter 23.762,00
--	------------------	-------------------	-------------	------------------------------	---

Kompressoraggregat D181108910	Luftkølet Max distance 8 m	Vægt 25	Dimensioner 430x450x300	Ekskl. moms og afgifter Indhent tilbud
---	-------------------------------	------------	----------------------------	--

El-tilslutning	230 / 50Hz
Optagen effekt	653 W - 3,6 A
Kølekapacitet	668 W*
Kølemiddel	R404a
*Ford. -10°C kondens. 54,4°C	

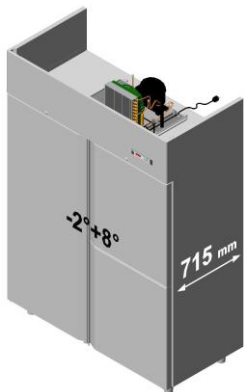
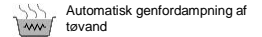
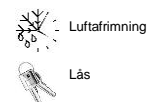
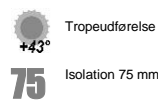

Indbygget kompressor A120/3M A141202003	Hylde 53x53 6	Hyldevinkler 6	Vægt 180	Dimensioner 1480x715x2085	Pris i DKK Ekskl. moms og afgifter 25.142,00
---	------------------	-------------------	-------------	------------------------------	---

For separat kompressor A120/3MR A141212003	Hylde 53x53 6	Hyldevinkler 6	Vægt 170	Dimensioner 1480x715x2085	Pris i DKK Ekskl. moms og afgifter 23.934,00
--	------------------	-------------------	-------------	------------------------------	---

Kompressoraggregat D181108910	Luftkølet Max afstand 8 m	Vægt 25	Dimensioner 430x450x300	Ekskl. moms og afgifter Indhent tilbud
---	------------------------------	------------	----------------------------	--

El-tilslutning	230 / 50Hz
Optagen effekt	653 W - 3,6 A
Kølekapacitet	668 W*
Kølemiddel	R404a
*Ford. -10°C kondens. 54,4°C	

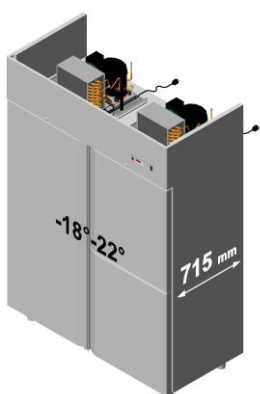
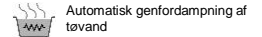
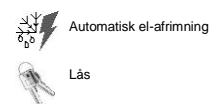
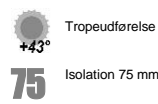

Indbygget kompressor A120/3B A141206003	Hylde 53x53 6	Hyldevinkler 6	Vægt 190	Dimensioner 1480x715x2085	Pris i DKK Ekskl. moms og afgifter 31.200,00
---	------------------	-------------------	-------------	------------------------------	---

For separat kompressor A120/3BR A141216003	Hylde 53x53 6	Hyldevinkler 6	Vægt 180	Dimensioner 1480x715x2085	Pris i DKK Ekskl. moms og afgifter 28.783,00
--	------------------	-------------------	-------------	------------------------------	---

Kompressoraggregat A+B	Luftkølet Max afstand 8 m	Dimensioner 430x450x300	Indhent tilbud	Indhent tilbud
----------------------------------	------------------------------	----------------------------	-----------------------	-----------------------

El-tilslutning	230 / 50Hz
Optagen effekt	1708 W - 9,6 A
Kølekapacitet	1564 W*
Kølemiddel	R404a
*Ford. -23,3°C kondens. 54,4°C	

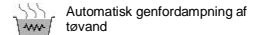
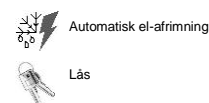
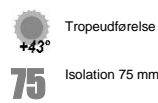

Catering

Skabe

Master 1200 liter

Dybde 715 mm

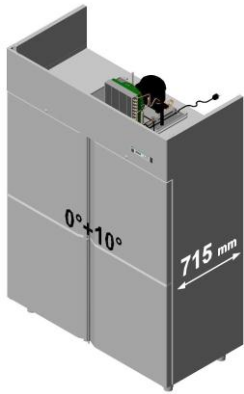

Indbygget kompressor A120/4N A141201004	Hylder 53x53 6	Hyldevinkler 6	Vægt 180	Dimensioner 1480x715x2085	Pris i DKK Ekskl. moms og afgifter 26.060,00
---	-------------------	-------------------	-------------	------------------------------	--

For separat kompressor A120/4NR A141211004	Hylder 53x53 6	Hyldevinkler 6	Vægt 170	Dimensioner 1480x715x2085	Pris i DKK Ekskl. moms og afgifter 24.852,00
--	-------------------	-------------------	-------------	------------------------------	--

Kompressoraggregat D181108910	Luftkølet Max afstand 8 m	Vægt 25	Dimensioner 430x450x300	Ekskl. moms og afgifter Indhent tilbud
---	------------------------------	------------	----------------------------	--

Ei-tilslutning	230 / 50Hz
Optagen effekt	653 W - 3,6 A
Kølekapacitet	668 W*
Kølemiddel	R404a
*Ford. -10°C kondens. 54,4°C	

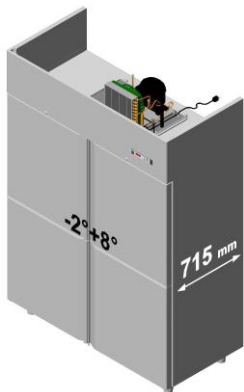
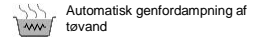
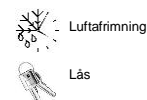
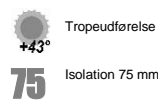

Indbygget kompressor A120/4M A141202004	Hylder 53x53 6	Hyldevinkler 6	Vægt 180	Dimensioner 1480x715x2085	Pris i DKK Ekskl. moms og afgifter 26.458,00
---	-------------------	-------------------	-------------	------------------------------	--

For separat kompressor A120/4MR A141212004	Hylder 53x53 6	Hyldevinkler 6	Vægt 170	Dimensioner 1480x715x2085	Pris i DKK Ekskl. moms og afgifter 25.255,00
--	-------------------	-------------------	-------------	------------------------------	--

Kompressoraggregat D181108910	Luftkølet Max afstand 8 m	Vægt 25	Dimensioner 430x450x300	Ekskl. moms og afgifter Indhent tilbud
---	------------------------------	------------	----------------------------	--

Ei-tilslutning	230 / 50Hz
Optagen effekt	653 W - 3,6 A
Kølekapacitet	668 W*
Kølemiddel	R404a
*Ford. -10°C kondens. 54,4°C	

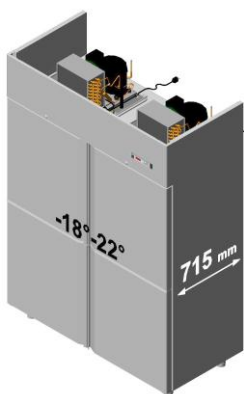
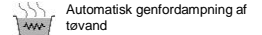
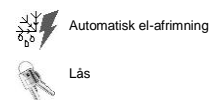
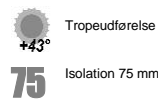

Indbygget kompressor A120/4B A141206004	Hylder 53x53 6	Hyldevinkler 6	Vægt 190	Dimensioner 1480x715x2085	Pris i DKK Ekskl. moms og afgifter 32.596,00
---	-------------------	-------------------	-------------	------------------------------	--

For separat kompressor A120/4BR A141216004	Hylder 53x53 6	Hyldevinkler 6	Vægt 180	Dimensioner 1480x715x2085	Pris i DKK Ekskl. moms og afgifter 30.180,00
--	-------------------	-------------------	-------------	------------------------------	--

Kompressoraggregat A+B	Luftkølet Max afstand 8 m	Dimensioner 430x450x300	Indhent tilbud	Indhent tilbud
----------------------------------	------------------------------	----------------------------	-----------------------	-----------------------

Ei-tilslutning	230 / 50Hz
Optagen effekt	1708 W - 9,6 A
Kølekapacitet	1564 W*
Kølemiddel	R404a
*Ford. -23,3°C kondens. 54,4°C	

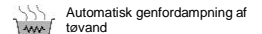
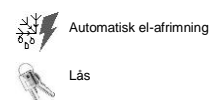
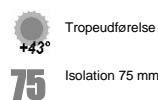







Catering

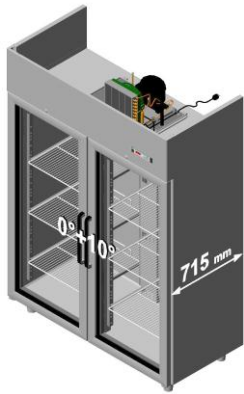



Skabe

Master 1200 liter

Dybde 715 mm









					Pris i DKK
Indbygget kompressor A120/2NV A141201007	Hylder 53x53 6	Hylddevinkler 6	Vægt 190	Dimensioner 1480x715x2085	
Ekskl. moms og afgifter 27.704,00					

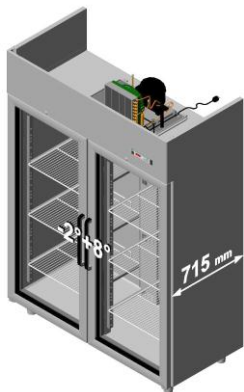
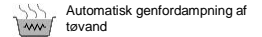
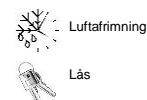
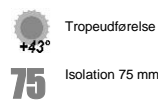



					Pris i DKK
For separat kompressor A120/2NRV A141211007	Hylder 53x53 6	Hylddevinkler 6	Vægt 180	Dimensioner 1480x715x2085	
Ekskl. moms og afgifter 26.495,00					

Kompressoraggregat D181108910	Luftkølet Max afstand 8 m	Vægt 25	Dimensioner 430x450x300	Ekskl. moms og afgifter Indhent tilbud
---	------------------------------	------------	----------------------------	--

El-tilslutning	230 / 50Hz
Optagen effekt	653 W - 3,6 A
Kølekapacitet	668 W*
Kølemiddel	R404a
*Ford. -10°C kondens. 54,4°C	









					Pris i DKK
Indbygget kompressor A120/2MV A141202007	Hylder 53x53 6	Hylddevinkler 6	Vægt 190	Dimensioner 1480x715x2085	
Ekskl. moms og afgifter 28.107,00					

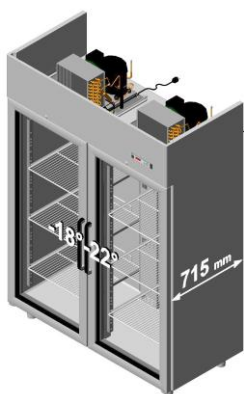
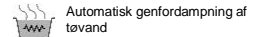
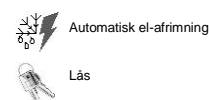
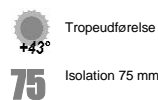



					Pris i DKK
For separat kompressor A120/2MRV A141212007	Hylder 53x53 6	Hylddevinkler 6	Vægt 180	Dimensioner 1480x715x2085	
Ekskl. moms og afgifter 26.898,00					

Kompressoraggregat D181108910	Luftkølet Max afstand 8 m	Vægt 25	Dimensioner 430x450x300	Ekskl. moms og afgifter Indhent tilbud
---	------------------------------	------------	----------------------------	--

El-tilslutning	230 / 50Hz
Optagen effekt	653 W - 3,6 A
Kølekapacitet	668 W*
Kølemiddel	R404a
*Ford. -10°C kondens. 54,4°C	



					Pris i DKK
Indbygget kompressor A120/2BV A141206007	Hylder 53x53 6	Hylddevinkler 6	Vægt 200	Dimensioner 1480x715x2085	
Ekskl. moms og afgifter 37.940,00					

					Pris i DKK
For separat kompressor A120/2BRV A141216007	Hylder 53x53 6	Hylddevinkler 6	Vægt 190	Dimensioner 1480x715x2085	
Ekskl. moms og afgifter 35.523,00					

Kompressoraggregat A+B	Luftkølet Max afstand 8 m	Dimensioner 430x450x300	Indhent tilbud	Indhent tilbud
----------------------------------	------------------------------	----------------------------	-----------------------	-----------------------

El-tilslutning	230 / 50Hz
Optagen effekt	2112 W - 11,8 A
Kølekapacitet	1870 W*
Kølemiddel	R404a
*Ford. -23,3°C kondens. 54,4°C	

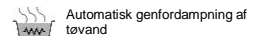
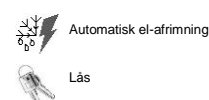
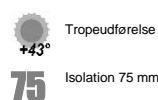

Catering

Skabe

Master 1400 liter GN2/1

Dybde 815 mm

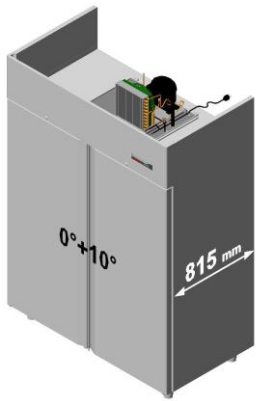

Indbygget kompressor A140/2N A141401002	Hylder GN2/1 6	Hyldevinkler 6	Vægt 190	Dimensioner 1480x815x2085	Pris i DKK Ekskl. moms og afgifter 24.063,00
--	-------------------	-------------------	-------------	------------------------------	---

For separat kompressor A140/2NR A141411002	Hylder GN2/1 6	Hyldevinkler 6	Vægt 180	Dimensioner 1480x815x2085	Pris i DKK Ekskl. moms og afgifter 22.860,00
---	-------------------	-------------------	-------------	------------------------------	---

Kompressoraggregat D181108910	Luftkølet Max afstand 8 m	Vægt 25	Dimensioner 430x450x300	Ekskl. moms og afgifter Indhent tilbud
---	------------------------------	------------	----------------------------	--

El-tilslutning	230 / 50Hz
Optagen effekt	653 W - 3,6 A
Kølekapacitet	668 W*
Kølemiddel	R404a
*Ford. -10°C kondens. 54,4°C	

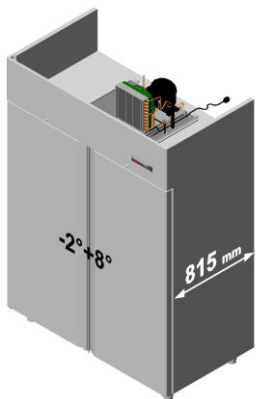
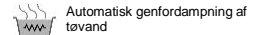
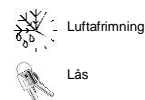
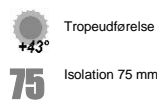

Indbygget kompressor A140/2M A141402002	Hylder GN2/1 6	Hyldevinkler 6	Vægt 190	Dimensioner 1480x815x2085	Pris i DKK Ekskl. moms og afgifter 24.476,00
--	-------------------	-------------------	-------------	------------------------------	---

For separat kompressor 140/2MR A141412002	Hylder GN2/1 6	Hyldevinkler 6	Vægt 180	Dimensioner 1480x815x2085	Pris i DKK Ekskl. moms og afgifter 23.268,00
--	-------------------	-------------------	-------------	------------------------------	---

Kompressoraggregat D181108910	Luftkølet Max distance 8 m	Vægt 25	Dimensioner 430x450x300	Ekskl. moms og afgifter Indhent tilbud
---	-------------------------------	------------	----------------------------	--

El-tilslutning	230 / 50Hz
Optagen effekt	653 W - 3,6 A
Kølekapacitet	668 W*
Kølemiddel	R404a
*Ford. -10°C kondens. 54,4°C	

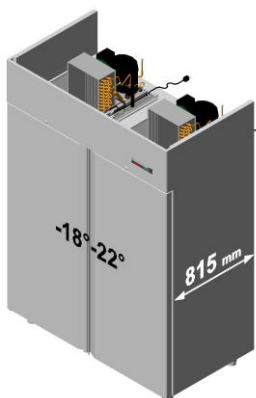
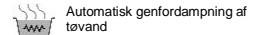
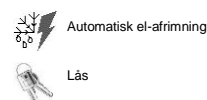
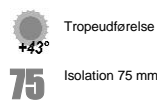

Indbygget kompressor A140/2B A141406002	Hylder GN2/1 6	Hyldevinkler 6	Vægt 200	Dimensioner 1480x815x2085	Pris i DKK Ekskl. moms og afgifter 30.287,00
--	-------------------	-------------------	-------------	------------------------------	---

For separat kompressor A140/2BR A141416002	Hylder GN2/1 6	Hyldevinkler 6	Vægt 190	Dimensioner 1480x815x2085	Pris i DKK Ekskl. moms og afgifter 27.870,00
---	-------------------	-------------------	-------------	------------------------------	---

Kompressoraggregat A+B	Luftkølet Max distance 8 m	Dimensioner 430x450x300	A -18°-22°C D182120410 B -18°-22°C D182120410	Indhent tilbud Indhent tilbud
----------------------------------	-------------------------------	----------------------------	--	---

El-tilslutning	230 / 50Hz
Optagen effekt	1708 W - 9,6 A
Kølekapacitet	1564 W*
Kølemiddel	R404a
*Ford. -23,3°C kondens. 54,4°C	

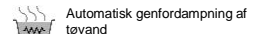
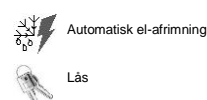
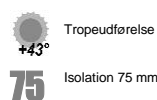

Catering

Skabe

Master 1400 liter GN2/1

Dybde 815 mm

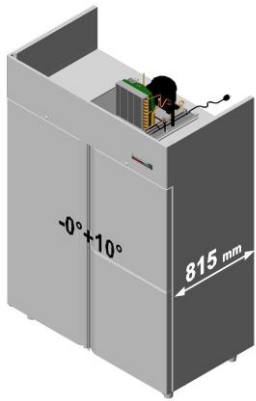

					Pris i DKK Ekskl. moms og afgifter 25.008,00
Indbygget kompressor A140/3N A141401003	Hylde GN2/1 6	Hyldevinkler 6	Vægt 190	Dimensioner 1480x815x2085	

					Pris i DKK Ekskl. moms og afgifter 23.800,00
For separat kompressor A140/3NR A141411003	Hylde GN2/1 6	Hyldevinkler 6	Vægt 180	Dimensioner 1480x815x2085	

Kompressoraggregat D181108910	Luftkølet Max afstand 8 m	Vægt 25	Dimensioner 430x450x300	Ekskl. moms og afgifter Indhent tilbud
---	------------------------------	------------	----------------------------	--

El-tilslutning	230 / 50Hz
Optagen effekt	653 W - 3,6 A
Kølekapacitet	668 W*
Kølemiddel	R404a
*Ford. -10°C kondens. 54,4°C	

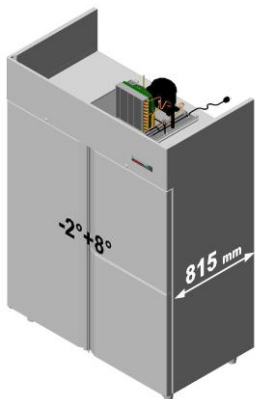
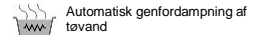
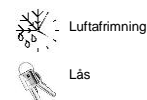
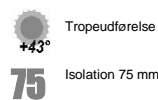

					Pris i DKK Ekskl. moms og afgifter 25.416,00
Indbygget kompressor A140/3M A141402003	Hylde GN2/1 6	Hyldevinkler 6	Vægt 190	Dimensioner 1480x815x2085	

					Pris i DKK Ekskl. moms og afgifter 24.208,00
For separat kompressor A140/3MR A141412003	Hylde GN2/1 6	Hyldevinkler 6	Vægt 180	Dimensioner 1480x815x2085	

Kompressoraggregat D181108910	Luftkølet Max afstand 8 m	Vægt 25	Dimensioner 430x450x300	Ekskl. moms og afgifter Indhent tilbud
---	------------------------------	------------	----------------------------	--

El-tilslutning	230 / 50Hz
Optagen effekt	653 W - 3,6 A
Kølekapacitet	668 W*
Kølemiddel	R404a
*Ford. -10°C kondens. 54,4°C	

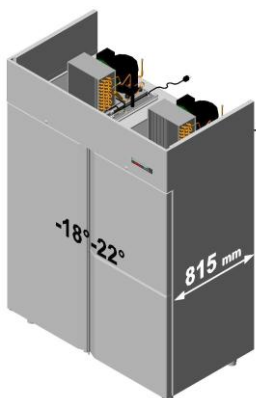
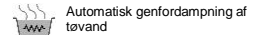
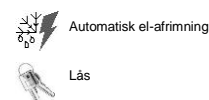
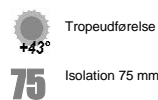

					Pris i DKK Ekskl. moms og afgifter 31.468,00
Indbygget kompressor A140/3B A141406003	Hylde GN2/1 6	Hyldevinkler 6	Vægt 200	Dimensioner 1480x815x2085	

					Pris i DKK Ekskl. moms og afgifter 29.062,00
For separat kompressor A140/3BR A141416003	Hylde GN2/1 6	Hyldevinkler 6	Vægt 190	Dimensioner 1480x815x2085	

Kompressoraggregat A+B	Luftkølet Max afstand 8 m	Dimensioner 430x450x300	A -18°-22°C D182120410	B -18°-22°C D182120410	Indhent tilbud Indhent tilbud
----------------------------------	------------------------------	----------------------------	---------------------------	---------------------------	---

El-tilslutning	230 / 50Hz
Optagen effekt	1708 W - 9,6 A
Kølekapacitet	1564 W*
Kølemiddel	R404a
*Ford. -23,3°C kondens. 54,4°C	

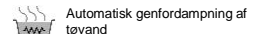
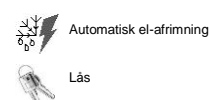
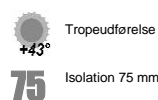

Catering

Skabe

Master 1400 liter GN2/1

Dybde 815 mm

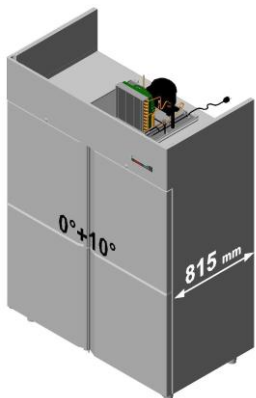

Indbygget kompressor A140/4N A141401004	Hylde GN2/1 6	Hyldevinkler 6	Vægt 190	Dimensioner 1480x815x2085	Pris i DKK Ekskl. moms og afgifter 26.329,00
--	------------------	-------------------	-------------	------------------------------	---

For separat kompressor A140/4NR A141411004	Hylde GN2/1 6	Hyldevinkler 6	Vægt 180	Dimensioner 1480x815x2085	Pris i DKK Ekskl. moms og afgifter 25.121,00
---	------------------	-------------------	-------------	------------------------------	---

Kompressoraggregat D181108910	Luftkølet Max afstand 8 m	Vægt 25	Dimensioner 430x450x300	Ekskl. moms og afgifter Indhent tilbud
---	------------------------------	------------	----------------------------	--

El-tilslutning	230 / 50Hz
Optagen effekt	653 W - 3,6 A
Kølekapacitet	668 W*
Kølemiddel	R404a
*Ford. -10°C kondens. 54,4°C	

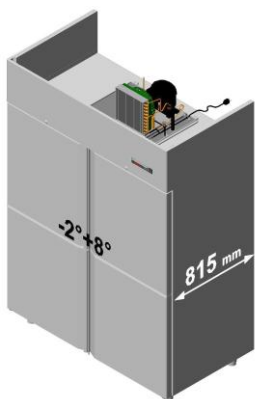
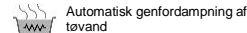
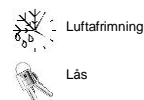
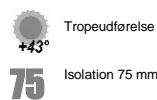

Indbygget kompressor A140/4M A141402004	Hylde GN2/1 6	Hyldevinkler 6	Vægt 190	Dimensioner 1480x815x2085	Pris i DKK Ekskl. moms og afgifter 26.732,00
--	------------------	-------------------	-------------	------------------------------	---

For separat kompressor A140/4MR A141412004	Hylde GN2/1 6	Hyldevinkler 6	Vægt 180	Dimensioner 1480x815x2085	Pris i DKK Ekskl. moms og afgifter 25.523,00
---	------------------	-------------------	-------------	------------------------------	---

Kompressoraggregat D181108910	Luftkølet Max afstand 8 m	Vægt 25	Dimensioner 430x450x300	Ekskl. moms og afgifter Indhent tilbud
---	------------------------------	------------	----------------------------	--

Voltage	230 / 50Hz
Total rate	653 W - 3,6 A
Cooling capacity	668 W*
Cooling gas	R404a
*Ford. -10°C kondens. 54,4°C	

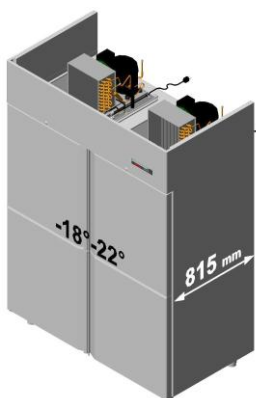
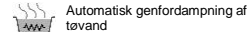
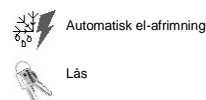
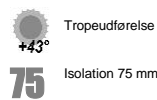

Indbygget kompressor A140/4B A141406004	Hylde GN2/1 6	Hyldevinkler 6	Vægt 200	Dimensioner 1480x815x2085	Pris i DKK Ekskl. moms og afgifter 32.865,00
--	------------------	-------------------	-------------	------------------------------	---

For separat kompressor A140/4BR A141416004	Hylde GN2/1 6	Hyldevinkler 6	Vægt 190	Dimensioner 1480x815x2085	Pris i DKK Ekskl. moms og afgifter 29.970,00
---	------------------	-------------------	-------------	------------------------------	---

Kompressoraggregat A+B	Luftkølet Max afstand 8 m	Dimensioner 430x450x300	Indhent tilbud	Indhent tilbud
----------------------------------	------------------------------	----------------------------	-----------------------	-----------------------

El-tilslutning	230 / 50Hz
Optagen effekt	1708 W - 9,6 A
Kølekapacitet	1564 W*
Kølemiddel	R404a
*Ford. -23,3°C kondens. 54,4°C	

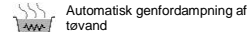
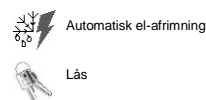
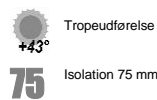

Catering

Skabe

Master 1400 liter GN2/1

Dybde 815 mm

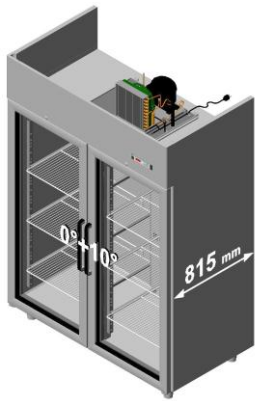

Indbygget kompressor A140/2NV A141401007	Hylder GN2/1 6	Hylddevinkler 6	Vægt 200	Dimensioner 1480x815x2085	Pris i DKK Ekskl. moms og afgifter 27.967,00
---	-------------------	--------------------	-------------	------------------------------	---

For separat kompressor A140/2NRV A141411007	Hylder GN2/1 6	Hylddevinkler 6	Vægt 190	Dimensioner 1480x815x2085	Pris i DKK Ekskl. moms og afgifter 26.764,00
--	-------------------	--------------------	-------------	------------------------------	---

Kompressoraggregat D181108910	Luftkølet Max afstand 8 m	Vægt 25	Dimensioner 430x450x300	Ekskl. moms og afgifter Indhent tilbud
---	------------------------------	------------	----------------------------	--

El-tilslutning	230 / 50Hz
Optagen effekt	653 W - 3,6 A
Kølekapacitet	668 W*
Kølemiddel	R404a
*Ford. -10°C kondens. 54,4°C	

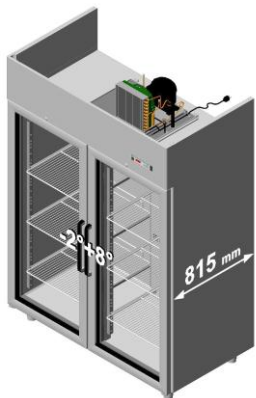
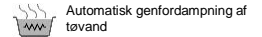
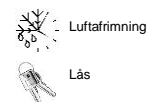
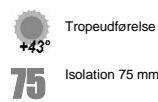

Indbygget kompressor A140/2MV A141402007	Hylder GN2/1 6	Hylddevinkler 6	Vægt 200	Dimensioner 1480x815x2085	Pris i DKK Ekskl. moms og afgifter 28.375,00
---	-------------------	--------------------	-------------	------------------------------	---

For separat kompressor A140/2MRV A141412007	Hylder GN2/1 6	Hylddevinkler 6	Vægt 190	Dimensioner 1480x815x2085	Pris i DKK Ekskl. moms og afgifter 27.172,00
--	-------------------	--------------------	-------------	------------------------------	---

Kompressoraggregat D181108910	Luftkølet Max afstand 8 m	Vægt 25	Dimensioner 430x450x300	Ekskl. moms og afgifter Indhent tilbud
---	------------------------------	------------	----------------------------	--

El-tilslutning	230 / 50Hz
Optagen effekt	653 W - 3,6 A
Kølekapacitet	668 W*
Kølemiddel	R404a
*Ford. -10°C kondens. 54,4°C	

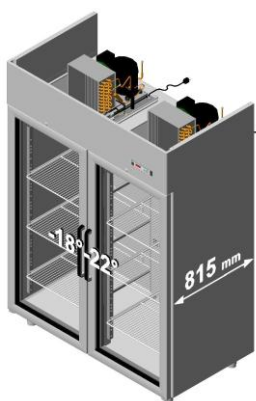
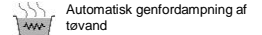
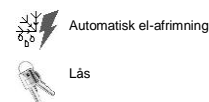
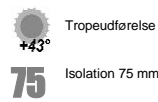

Indbygget kompressor A140/2BV A141406007	Hylder GN2/1 6	Hylddevinkler 6	Vægt 210	Dimensioner 1480x815x2085	Pris i DKK Ekskl. moms og afgifter 38.208,00
---	-------------------	--------------------	-------------	------------------------------	---

For separat kompressor A140/2BRV A141416007	Hylder GN2/1 6	Hylddevinkler 6	Vægt 200	Dimensioner 1480x815x2085	Pris i DKK Ekskl. moms og afgifter 35.797,00
--	-------------------	--------------------	-------------	------------------------------	---

Kompressoraggregat A+B	Luftkølet Max distance 8 m	Dimensioner 430x450x300	Indhent tilbud	Indhent tilbud
----------------------------------	-------------------------------	----------------------------	-----------------------	-----------------------

El-tilslutning	230 / 50Hz
Optagen effekt	2112 W - 11,8 A
Kølekapacitet	1870 W*
Kølemiddel	R404a
*Ford. -23,3°C kondens. 54,4°C	

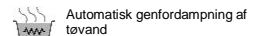
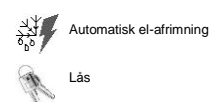
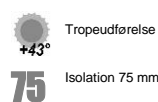

Catering

Skabe

Master Fisk 350-700-1400 liter

Dybde 715-815 mm



Indbygget kompressor A30/1P A140303001	Bakke i abs GN1/1 3	Hyldevinkler 3	Vægt 100	Dimensioner 535x715x2085	Pris i DKK Ekskl. moms og afgifter 17.067,00
--	------------------------	-------------------	-------------	-----------------------------	---

For separat kompressor A30/1PR A140313001	Bakke i abs GN1/1 3	Hyldevinkler 3	Vægt 90	Dimensioner 535x715x2085	Pris i DKK Ekskl. moms og afgifter 16.207,00
---	------------------------	-------------------	------------	-----------------------------	---

Kompressoraggregat D181106110	Luftkølet Max afstand 8 m	Vægt 25	Dimensioner 430x450x300	Ekskl. moms og afgifter Indhent tilbud
---	------------------------------	------------	----------------------------	--

El-tilslutning	230 / 50Hz
Optagen effekt	328 W - 1,8 A
Kølekapacitet	368 W*
Kølemiddel	R404a
*Ford. -10°C kondens. 54,4°C	

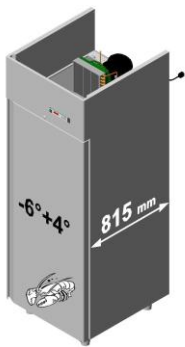
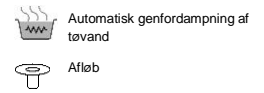
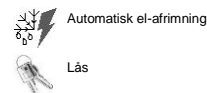

Indbygget kompressor A70/1P A140703001	Bakke i abs GN1/1 6	Hyldevinkler 3	Vægt 125	Dimensioner 740x815x2085	Pris i DKK Ekskl. moms og afgifter 18.169,00
--	------------------------	-------------------	-------------	-----------------------------	---

For separat kompressor A70/1PR A140713001	Bakke i abs GN1/1 6	Hyldevinkler 3	Vægt 115	Dimensioner 740x815x2085	Pris i DKK Ekskl. moms og afgifter 17.202,00
---	------------------------	-------------------	-------------	-----------------------------	---

Kompressoraggregat D181106110	Luftkølet Max afstand 8 m	Vægt 25	Dimensioner 430x450x300	Ekskl. moms og afgifter Indhent tilbud
---	------------------------------	------------	----------------------------	--

El-tilslutning	230 / 50Hz
Optagen effekt	486 W - 2,6 A
Kølekapacitet	519 W*
Kølemiddel	R404a
*Ford. -10°C kondens. 54,4°C	

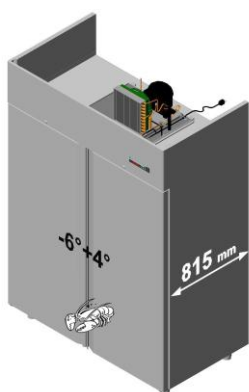
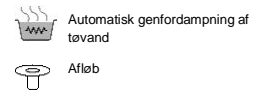
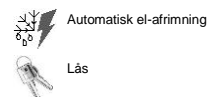
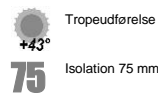

Indbygget kompressor A140/2P A141403002	Bakke i abs GN1/1 12	Hyldevinkler 6	Vægt 190	Dimensioner 1480x815x2085	Pris i DKK Ekskl. moms og afgifter 26.930,00
---	-------------------------	-------------------	-------------	------------------------------	---

For separat kompressor A140/2PR A141413002	Bakke i abs GN1/1 12	Hyldevinkler 6	Vægt 180	Dimensioner 1480x815x2085	Pris i DKK Ekskl. moms og afgifter 26.071,00
--	-------------------------	-------------------	-------------	------------------------------	---

Kompressoraggregat D181108910	Luftkølet Max afstand 8 m	Vægt 25	Dimensioner 430x450x300	Ekskl. moms og afgifter Indhent tilbud
---	------------------------------	------------	----------------------------	--

El-tilslutning	230 / 50Hz
Optagen effekt	653 W - 3,6 A
Kølekapacitet	668 W*
Kølemiddel	R404a
*Ford. -10°C kondens. 54,4°C	

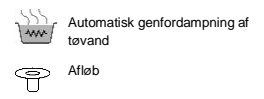
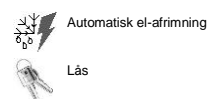
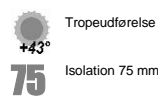

Catering

Skabe

Master Combi 700 liter GN2/1

Dybde 815 mm

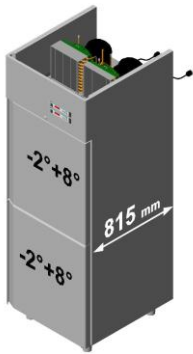

					Pris i DKK Ekskl. moms og afgifter 24.457,00
Indbygget kompressor A70/2MM A140702202	Hylde GN2/1 4	Hyldevinkler 4	Vægt 135	Dimensioner 740x815x2085	

					Pris i DKK Ekskl. moms og afgifter 22.524,00
For separat kompressor A70/2MMR A140712202	Hylde GN2/1 4	Hyldevinkler 4	Vægt 125	Dimensioner 740x815x2085	

Kompressoraggregat A+B	Luftkølet Max afstand 8 m	Dimensioner 430x450x300	A -2°+8°C D181104410	B -2°+8°C D181104410	Indhent tilbud	Indhent tilbud
----------------------------------	------------------------------	----------------------------	-------------------------	-------------------------	-----------------------	-----------------------

El-tilslutning	230 / 50Hz
Optagen effekt	656 W - 3,6 A
Kølekapacitet	368+368 W*
Kølemiddel	R404a
*Ford. -10°C kondens. 54,4°C	

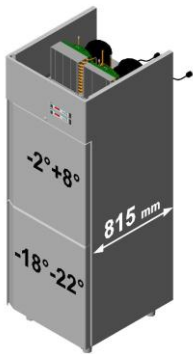
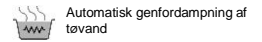
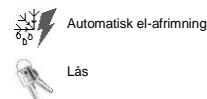
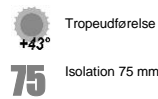

					Pris i DKK Ekskl. moms og afgifter 25.918,00
Indbygget kompressor A70/2MB A140702602	Hylde GN2/1 4	Hyldevinkler 4	Vægt 135	Dimensioner 740x815x2085	

					Pris i DKK Ekskl. moms og afgifter 23.179,00
For separat kompressor A70/2MBR A140712602	Hylde GN2/1 4	Hyldevinkler 4	Vægt 125	Dimensioner 740x815x2085	

Kompressoraggregat A+B	Luftkølet Max afstand 8 m	Dimensioner 430x450x300	A -2°+8°C D181104410	B -18°-22°C D182117410	Indhent tilbud	Indhent tilbud
----------------------------------	------------------------------	----------------------------	-------------------------	---------------------------	-----------------------	-----------------------

El-tilslutning	230 / 50Hz
Optagen effekt	825 W - 4,7 A
Kølekapacitet	368*+464 W**
Kølemiddel	R404a
*Ford. -10°C kondens. 54,4°C **Ford. -23,3°C kondens. 54,4°C	

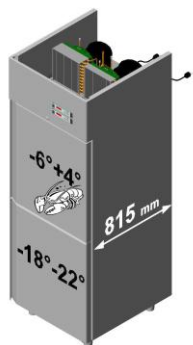
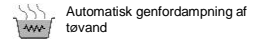
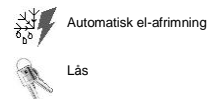
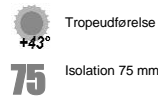

					Pris i DKK Ekskl. moms og afgifter 28.437,00
Indbygget kompressor A70/2PB A140703602	Hylde GN2/1 2	Bakke i abs GN1/1 4	Vægt 135	Dimensioner 740x815x2085	

					Pris i DKK Ekskl. moms og afgifter 25.698,00
For separat kompressor A70/2PBR A140713602	Hylde GN2/1 2	Bakke i abs GN1/1 4	Vægt 125	Dimensioner 740x815x2085	

Kompressoraggregat A+B	Luftkølet Max afstand 8 m	Dimensioner 430x450x300	A -6°+4°C D181104410	B -18°-22°C D182117410	Indhent tilbud	Indhent tilbud
----------------------------------	------------------------------	----------------------------	-------------------------	---------------------------	-----------------------	-----------------------

El-tilslutning	230 / 50Hz
Optagen effekt	825 W - 4,7 A
Kølekapacitet	368*+464 W**
Kølemiddel	R404a
*Ford. -10°C kondens. 54,4°C **Ford. -23,3°C kondens. 54,4°C	

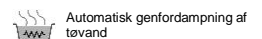
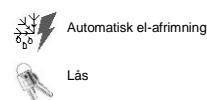

Catering

Skabe

Master Combi 1400 liter GN2/1

Dybde 815 mm

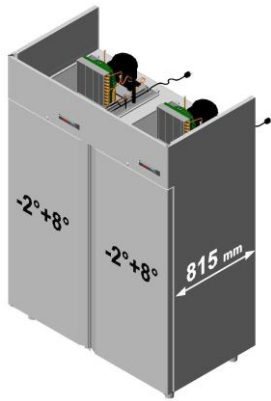

					Pris i DKK Ekskl. moms og afgifter 30.217,00
Indbygget kompressor A140/2MM A141402202	Hylde GN2/1 6	Hyldevinkler 6	Vægt 200	Dimensioner 1480x815x2085	

					Pris i DKK Ekskl. moms og afgifter 28.284,00
For separat kompressor A140/2MMR A141412202	Hylde GN2/1 6	Hyldevinkler 6	Vægt 180	Dimensioner 1480x815x2085	

Kompressoraggregat A+B	Luftkølet Max afstand 8 m	Dimensioner 430x450x300	A -2°+8°C D181106110	B -2°+8°C D181106110	Indhent tilbud	Indhent tilbud
----------------------------------	------------------------------	----------------------------	-------------------------	-------------------------	-----------------------	-----------------------

Ei-tilslutning	230 / 50Hz
Optagen effekt	656 W - 3,6 A
Kølekapacitet	368+368 W*
Kølemiddel	R404a
*Ford. -10°C kondens. 54,4°C	

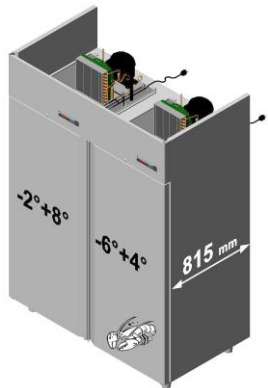
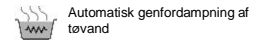
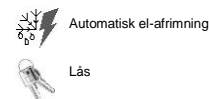
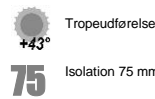

					Pris i DKK Ekskl. moms og afgifter 34.750,00
Indbygget kompressor A140/2MP A141402302	Hylde GN2/1 3	Bakke i abs GN1/1 6	Vægt 200	Dimensioner 1480x815x2085	

					Pris i DKK Ekskl. moms og afgifter 32.816,00
For separat kompressor A140/2MPR A141412302	Hylde GN2/1 3	Bakke i abs GN1/1 6	Vægt 180	Dimensioner 1480x815x2085	

Kompressoraggregat A+B	Luftkølet Max afstand 8 m	Dimensioner 430x450x300	A -2°+8°C D181106110	B -6°+4°C D181106110	Indhent tilbud	Indhent tilbud
----------------------------------	------------------------------	----------------------------	-------------------------	-------------------------	-----------------------	-----------------------

Ei-tilslutning	230 / 50Hz
Optagen effekt	814 W - 4,4 A
Kølekapacitet	368+519 W*
Kølemiddel	R404a
*Ford. -10°C kondens. 54,4°C	

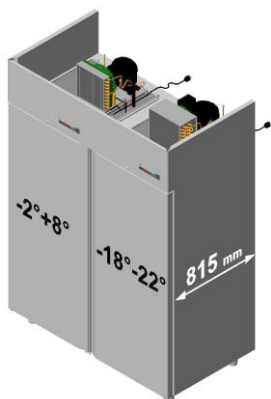
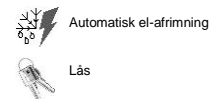
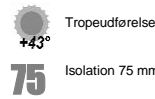

					Pris i DKK Ekskl. moms og afgifter 33.386,00
Indbygget kompressor A140/2MB A141402602	Hylde GN2/1 6	Hyldevinkler 6	Vægt 210	Dimensioner 1480x815x2085	

					Pris i DKK Ekskl. moms og afgifter 30.647,00
For separat kompressor A140/2MBR A141412602	Hylde GN2/1 6	Hyldevinkler 6	Vægt 190	Dimensioner 1480x815x2085	

Kompressoraggregat A+B	Luftkølet Max afstand 8 m	Dimensioner 430x450x300	A -2°+8°C D181106110	B -18°-22°C D182120410	Indhent tilbud	Indhent tilbud
----------------------------------	------------------------------	----------------------------	-------------------------	---------------------------	-----------------------	-----------------------

Ei-tilslutning	230 / 50Hz
Optagen effekt	1182 W - 6,6 A
Kølekapacitet	368*+782 W**
Kølemiddel	R404a
*Ford. -10°C kondens. 54,4°C **Ford. -23,3°C kondens. 54,4°C	

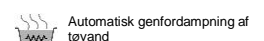
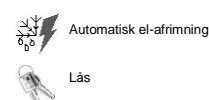

Catering

Skabe

Master Combi 1400 liter GN2/1

Dybde 815 mm

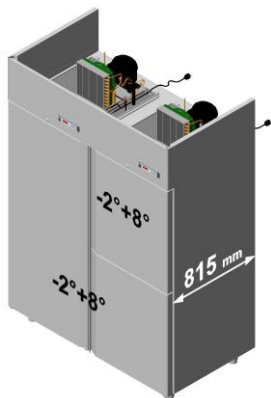

					Pris i DKK Ekskl. moms og afgifter 32.430,00
Indbygget kompressor A140/3MML A141402293	Hylder GN2/1 7	Hyldvinkler 7	Vægt 200	Dimensioner 1480x815x2085	
					Pris i DKK Ekskl. moms og afgifter 30.496,00
For separat kompressor A140/3MMRL A141412293	Hylder GN2/1 7	Hyldvinkler 7	Vægt 180	Dimensioner 1480x815x2085	
Kompressoraggregat A+B	Luftkølet Max afstand 8 m	Dimensioner 430x450x300	A -2°+8°C D181108910 B -2°+8°C D181104410 Indhent tilbud Indhent tilbud		

El-tilslutning	230 / 50Hz
Optagen effekt	981 W - 5,4 A
Kølekapacitet	668+368 W*
Kølemiddel	R404a
*Ford. -10°C kondens.54,4°C	

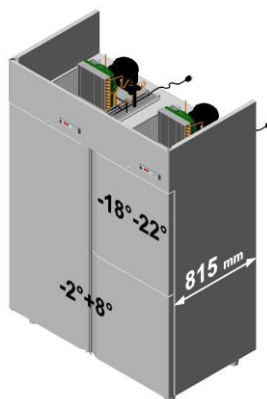
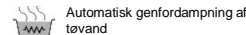
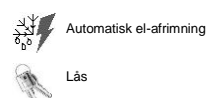

					Pris i DKK Ekskl. moms og afgifter 35.636,00
Indbygget kompressor A140/3MBL A141402693	Hylder GN2/1 7	Hyldvinkler 7	Vægt 200	Dimensioner 1480x815x2085	
					Pris i DKK Ekskl. moms og afgifter 32.897,00
For separat kompressor A140/3MBRL A141412693	Hylder GN2/1 7	Hyldvinkler 7	Vægt 180	Dimensioner 1480x815x2085	
Kompressoraggregat A+B	Luftkølet Max afstand 8 m	Dimensioner 430x450x300	A -2°+8°C D181108910 B -18°-22°C D182117410 Indhent tilbud Indhent tilbud		

El-tilslutning	230 / 50Hz
Optagen effekt	1507 W - 8,4 A
Kølekapacitet	668*+782 W**
Kølemiddel	R404a
**Ford. -10°C kondens.54,4°C **Ford. -10°C kondens.54,4°C	

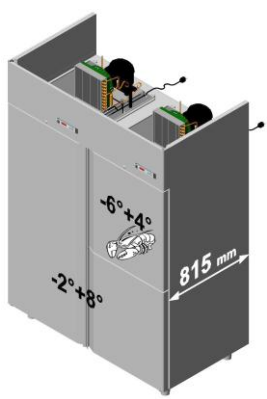
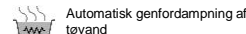
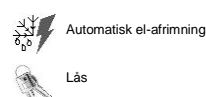

					Pris i DKK Ekskl. moms og afgifter 35.475,00
Indbygget kompressor A140/3MPL A141402393	Hylder GN2/1 5	Bakke i abs GN1/1 4	Vægt 200	Dimensioner 1480x815x2085	
					Pris i DKK Ekskl. moms og afgifter 33.541,00
For separat kompressor A140/3MPRL A141412393	Hylder GN2/1 5	Bakke i abs GN1/1 4	Vægt 180	Dimensioner 1480x815x2085	
Kompressoraggregat A+B	Luftkølet Max afstand 8 m	Dimensioner 430x450x300	A -2°+8°C D181108910 B -6°+4°C D181104410 Indhent tilbud Indhent tilbud		

El-tilslutning	230 / 50Hz
Optagen effekt	1139 W - 6,2 A
Kølekapacitet	668+519 W*
Kølemiddel	R404a
*Ford. -10°C kondens.54,4°C	

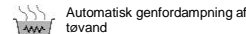
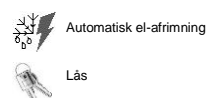

Catering

Skabe

Master Combi 1400 liter GN2/1

Dybde 815 mm

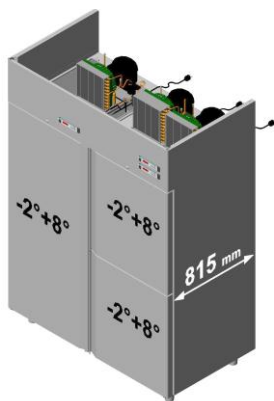

					Pris i DKK
Indbygget kompressor A140/3MMM A141402223	Hylde GN2/1 7	Hyldevinkler 7	Vægt 210	Dimensioner 1480x815x2085	Ekskl. moms og afgifter 39.019,00
					Pris i DKK
For separat kompressor A140/3MMMR A141412223	Hylde GN2/1 7	Hyldevinkler 7	Vægt 200	Dimensioner 1480x815x2085	Ekskl. moms og afgifter 36.119,00
Kompressoraggregat	Luftkølet		A -2°+8°C D181106110	B -2°+8°C D181104410	C -2°+8°C D181104410
A+B+C	Max distance 8 m	Indhent tilbud	Indhent tilbud	Indhent tilbud	

El-tilslutning	230 / 50Hz
Optagen effekt	984 W - 5,4 A
Kølekapacitet	368+368+368 W*
Kølemiddel	R404a
*Ford. -10°C kondens.54,4°C	

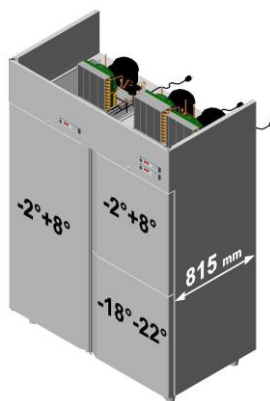
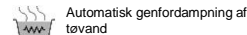
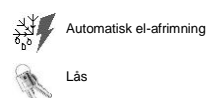

					Pris i DKK
Indbygget kompressor A140/3MMB A141402263	Hylde GN2/1 7	Hyldevinkler 7	Vægt 210	Dimensioner 1480x815x2085	Ekskl. moms og afgifter 39.996,00
					Pris i DKK
For separat kompressor A140/3MMBR A141412263	Hylde GN2/1 7	Hyldevinkler 7	Vægt 200	Dimensioner 1480x815x2085	Ekskl. moms og afgifter 36.291,00
Kompressoraggregat	Luftkølet		A -2°+8°C D181106110	B -2°+8°C D181104410	C -18°-22°C D182117410
A+B+C	Max afstand 8 m	Indhent tilbud	Indhent tilbud	Indhent tilbud	



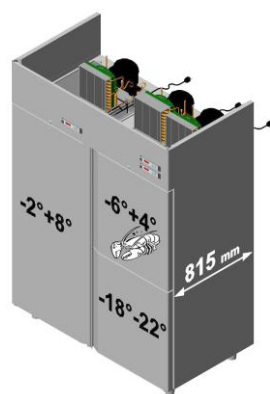
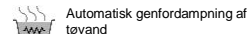
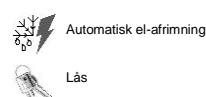
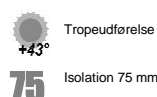





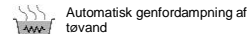
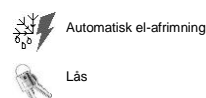
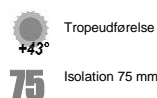

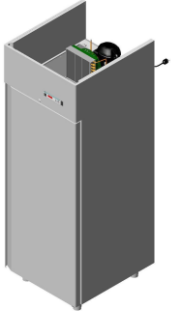

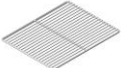

El-tilslutning	230 / 50Hz
Optagen effekt	1153 W - 6,5 A
Kølekapacitet	368+368+464 W*
Kølemiddel	R404a
*Ford. -10°C kondens.54,4°C **Ford. -23,3°C kondens. 54,4°C	

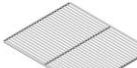









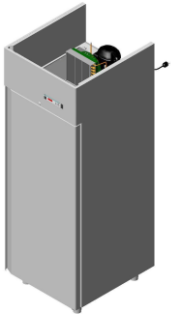

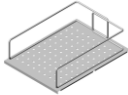

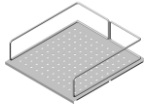

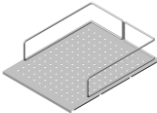

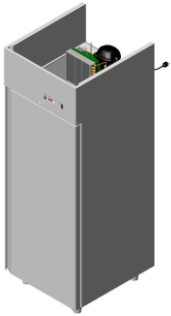
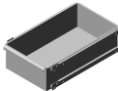
					Pris i DKK
Indbygget kompressor A140/3MPB A141402363	Hylde GN2/1 5	Bakke i abs GN1/1 4	Vægt 210	Dimensioner 1480x815x2085	Ekskl. moms og afgifter 43.202,00
					Pris i DKK
For separat kompressor A140/3MPBR A141412363	Hylde GN2/1 5	Bakke i abs GN1/1 4	Vægt 200	Dimensioner 1480x815x2085	Ekskl. moms og afgifter 39.497,00
Kompressoraggregat	Luftkølet		A -2°+8°C D181106110	B -6°+4°C D181104410	C -18°-22°C D182117410
A+B+C	Max afstand 8 m	Indhent tilbud	Indhent tilbud	Indhent tilbud	

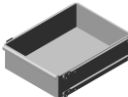
El-tilslutning	230 / 50Hz
Optagen effekt	1153 W - 6,5 A
Kølekapacitet	368+368+464W**
Kølemiddel	R404a
*Ford. -10°C kondens.54,4°C **Ford. -23,3°C kondens. 54,4°C	

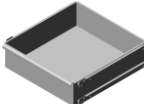

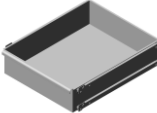
>Product	>>Type	>>>Varenummer	>>>Varenummer
 <p>Master Cabinets</p>	Master 350 liter	O221325530 Plastik coated trådhylde GN1/1	O121150520 Rustfri hyldébærere U profile, sæt af 2 stk. Type C – 505 mm
		 Pris i DKK (ekskl. moms) 210,00	 Pris i DKK (ekskl. moms) 210,00
	Master 500 liter	O223420530 Plastik coated trådhylde 43x53	O121150520 Rustfri hyldébærere U profile, sæt af 2 stk. Type C – 505 mm
		 Pris i DKK (ekskl. moms) 210,00	 Pris i DKK (ekskl. moms) 210,00
	Master 600/1200 liter	O223530530 Plastik coated trådhylde 53x53	O121150520 Rustfri hyldébærere U profile, sæt af 2 stk. Type C – 505 mm
		 Pris i DKK (ekskl. moms) 210,00	 Pris i DKK (ekskl. moms) 210,00
	Master 650 liter	O221650530 Plastik coated trådhylde GN2/1	O121150520 Rustfri hyldébærere U profile, sæt af 2 stk. Type C – 505 mm
	 Pris i DKK (ekskl. moms) 210,00	 Pris i DKK (ekskl. moms) 210,00	
Master 700/1400 liter Master Combi 700/1400 liter	O221650530 Plastik coated trådhylde GN2/1	O121160520 Rustfri hyldébærere U profile, sæt af 2 stk. Type C – 605 mm	
	 Pris i DKK (ekskl. moms) 210,00	 Pris i DKK (ekskl. moms) 210,00	
Master 700 liter Fisk Master Combi 700/1400 liter Fisk	O325311020 Bakke i ABS for fisk, GN 1/1	O121160520 Rustfri hyldébærere U profile, sæt af 2 stk. Type C – 605 mm	
	 Pris i DKK (ekskl. moms) 410,00	 Pris i DKK (ekskl. moms) 210,00	
Alle modeller	O841100020 HACCP grafisk recorder (-10/+4,0°C) indbygges på fabrik	O841200020 HACCP grafisk recorder (-35/+15°C) indbygges på fabrik	
	 Pris i DKK (ekskl. moms) 9.323,00	 Pris i DKK (ekskl. moms) 9.323,00	
Alle modeller		O444000020 Rustfrit hjulsæt (Sving- og låsbare)	
		 Pris i DKK (ekskl. moms) 1.641,00	

>Product	>>Type	>>>Varenummer	>>>Varenummer
Master Cabinets 	350 liter	O26132530 Rustfri hyld for flasker (skal have almindelig hyld under)	O615288004 Kit af hyldevanger (monteres på fabrik)
		 Pris i DKK (ekskl. moms) 671,00	 Pris i DKK (ekskl. moms) 522,00
	>>Type	>>>Varenummer	>>>Varenummer
	500 liter	O263420530 Rustfri hyld for flasker (skal have almindelig hyld under)	O615288004 Kit af hyldevanger (monteres på fabrik)
	 Pris i DKK (ekskl. moms) 709,00	 Pris i DKK (ekskl. moms) 522,00	
>>Type	>>>Varenummer	>>>Varenummer	
600/1200 liter	O263530530 Rustfri hyld for flasker (skal have almindelig hyld under)	O615288004 Kit af hyldevanger (monteres på fabrik)	
	 Pris i DKK (ekskl. moms) 746,00	 Pris i DKK (ekskl. moms) 522,00	
>>Type	>>>Varenummer	>>>Varenummer	
700/1400 liter	O261650530 Rustfri hyld for flasker (skal have almindelig hyld under)	O615288004 Kit af hyldevanger (monteres på fabrik)	
	 Pris i DKK (ekskl. moms) 783,00	 Pris i DKK (ekskl. moms) 522,00	
>Product	>>Type	>>>Varenummer	>>>Varenummer
Master Cabinets 	350 liter	L313003304 Rustfri skuffe (monteres på fabrik) 350 H150 mm	O615288004 Kit af hyldevanger (monteres på fabrik)
		 Pris i DKK (ekskl. moms) 1.678,00	 Pris i DKK (ekskl. moms) 522,00
	>>Type	>>>Varenummer	>>>Varenummer
	500 liter	L313005304 Rustfri skuffe (monteres på fabrik) 500 H150 mm	O615288004 Kit af hyldevanger (monteres på fabrik)
	 Pris i DKK (ekskl. moms) 1.716,00	 Pris i DKK (ekskl. moms) 522,00	
>>Type	>>>Varenummer	>>>Varenummer	
600/1200 liter	L313006304 Rustfri skuffe (monteres på fabrik) 600 H150 mm	O615288004 Kit af hyldevanger (monteres på fabrik)	
	 Pris i DKK (ekskl. moms) 1.753,00	 Pris i DKK (ekskl. moms) 522,00	
>>Type	>>>Varenummer	>>>Varenummer	
700/1400 liter	L313007304 Rustfri skuffe (monteres på fabrik) 700 H150 mm	O615288004 Kit af hyldevanger (monteres på fabrik)	
	 Pris i DKK (ekskl. moms) 1.790,00	 Pris i DKK (ekskl. moms) 522,00	

EGENSKABER

Udvendig/indvendig i rustfrit AISI 304 stål

Isolationstykkelse 75 mm

Afrundede hjørner

Selvlukkende vendbare døre, der kan åbnes 105°

Magnet tætningslister – nemme at rengøre og udskifte

Dørlås

13 mm rustfrit gulv

Konstruerede for drift ved omgivelsestemperaturer på op til +43° C

Ventileret kulde

Coated fordamper (cataphoresis) for at modvirke tæring

Fuldt udskifteligt kølesystem

Automatisk afrimning (styret af føler)

Genfordampning af tøvand

Elektronisk styring

Lys



Indkøring GN2/1



Side 41

GN2/1 (max 20)

Gennemkøring GN2/1



Side 43

GN2/1 (max 20)

Indkøring GN2/1



Side 42

GN2/1 (max 20+20)

Gennemkøring GN2/1



Side 44

GN2/1 (max 20+20)



Catering

Indkørings-/gennemkøringskøleskabe

Indkøring GN2/1

Dybde 815 mm



Indbygget kompressor
J100/1M
J111002001

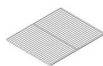

Hylder GN2/1



Vægt
130



Dimensioner
810x815x2115

Pris i DKK

Ekst. moms og afgifter
27.058,00

20 GN2/1

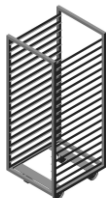

Vægt
40



Dimensioner
598x660x1630

Pris i DKK

Ekst. moms og afgifter
v. samfragt med skab
6.422,00

El-tilslutning	230 / 50Hz
Optagen effekt	992 W - 5,6 A
Kølekapacitet	887 W*
Kølemiddel	R134a
*Ford. -10°C kondens.54,4°C	



Tropeudførelse

75

Isolation 75 mm



Ventileret køling



Lys



Automatisk el-afrimning



Lås



Automatisk genfordampning af tøvand

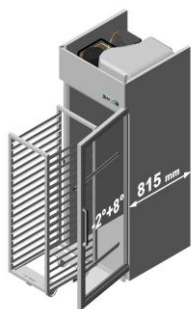

Indbygget kompressor
J100/1MV
J111002006

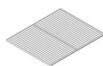

Hylder GN2/1



Vægt
140



Dimensioner
810x815x2115

Pris i DKK

Ekst. moms og afgifter
30.817,00

20 GN2/1

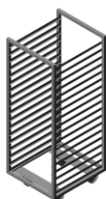

Vægt
40



Dimensioner
598x660x1630

Pris i DKK

Ekst. moms og afgifter
v. samfragt med skab
6.422,00

El-tilslutning	230 / 50Hz
Optagen effekt	992 W - 5,6 A
Kølekapacitet	887 W*
Kølemiddel	R134a
*Ford. -10°C kondens.54,4°C	



Tropeudførelse

75

Isolation 75 mm



Ventileret køling



Lys



Automatisk el-afrimning



Lås



Automatisk genfordampning af tøvand

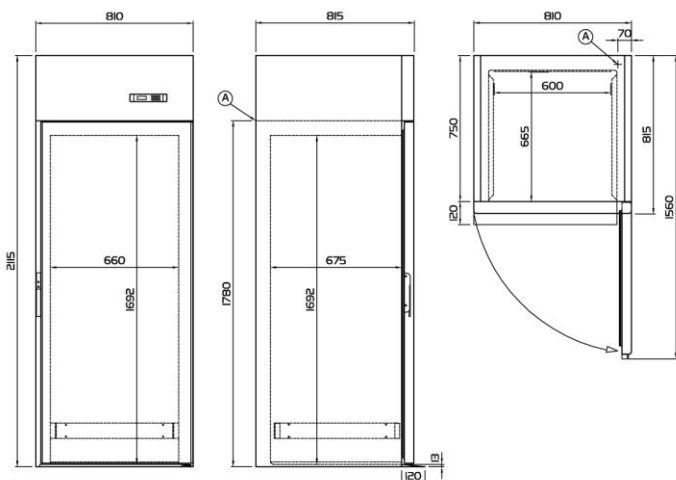

Ⓐ POWER SUPPLY CABLE OUTLET

Catering

Indkørings-/gennemkøringskøleskabe

Indkøring GN2/1

Dybde 815 mm

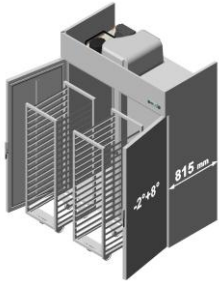

Indbygget kompressor
J160/2M
J111602002

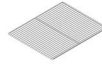

Hylder GN2/1



Vægt
190



Dimensioner
1620x815x2115

Pris i DKK

Ekskl. moms og afgifter
35.537,00

20 GN2/1

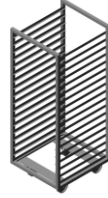

Vægt
40



Dimensioner
598x660x1630

Pris i DKK

Ekskl. moms og afgifter
v. samfragt med skab
6.422,00

El-tilslutning	230 / 50Hz
Optagen effekt	992 W - 5,6 A
Kølekapacitet	887 W*
Kølemiddel	R134a
*Ford. -10°C kondens.54,4°C	



+43° Tropeudførelse
75 Isolation 75 mm



Ventileret køling



Lys



Automatisk el-afrimning



Lås



Automatisk genfordampning af tøvand

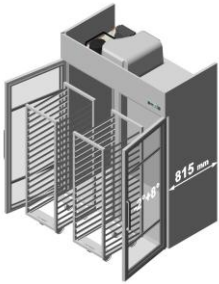

Indbygget kompressor
J160/2MV
J111602007

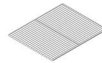

Hylder GN2/1



Vægt
210



Dimensioner
1620x815x2115

Pris i DKK

Ekskl. moms og afgifter
43.066,00

20 GN2/1

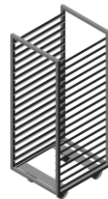

Vægt
40



Dimensioner
598x660x1630

Pris i DKK

Ekskl. moms og afgifter
v. samfragt med skab
6.422,00

El-tilslutning	230 / 50Hz
Optagen effekt	992 W - 5,6 A
Kølekapacitet	887 W*
Kølemiddel	R134a
*Ford. -10°C kondens.54,4°C	



+43° Tropeudførelse
75 Isolation 75 mm



Ventileret køling



Lys



Automatisk el-afrimning



Lås



Automatisk genfordampning af tøvand

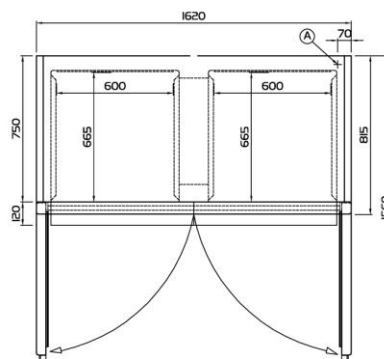
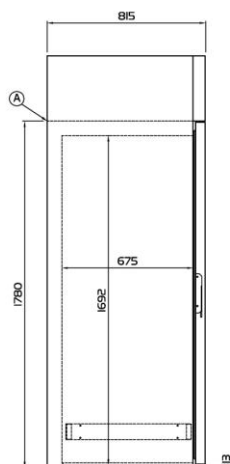
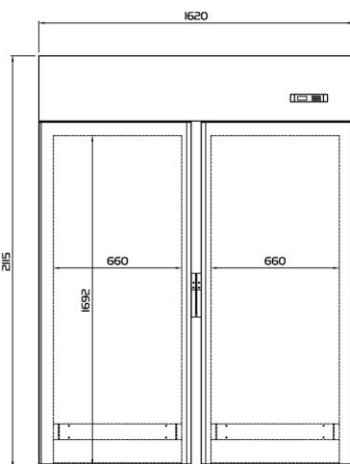

Ⓐ POWER SUPPLY CABLE OUTLET

Catering

Indkørings-/gennemkøringskøleskabe

Gennemkøring GN2/1

Dybde 880 mm



Indbygget kompressor
J110/2M
J121102002

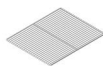

Hylder GN2/1



Vægt
140



Dimensioner
810x880x2115

Pris i DKK

Ekskl. moms og afgifter
30.194,00

20 GN2/1

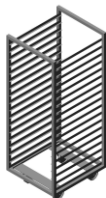

Vægt



Dimensioner
598x660x1630

Pris i DKK

Ekskl. moms og afgifter
v. samfragt med skab
6.422,00

El-tilslutning	230 / 50Hz
Optagen effekt	992 W - 5,6 A
Kølekapacitet	887 W*
Kølemiddel	R134a
*Ford. -10°C kondens.54,4°C	



+43° Tropeudførelse
75 Isolation 75 mm



Ventileret køling
Lys



Automatisk el-afrimning
Lås



Automatisk genfordampning af tøvand



Indbygget kompressor
J110/2MV1
J121102003

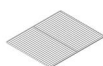

Hylder GN2/1



Vægt
150



Dimensioner
810x880x2115

Pris i DKK

Ekskl. moms og afgifter
32.074,00

20 GN2/1

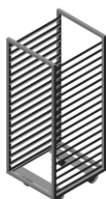

Vægt



Dimensioner
598x660x1630

Pris i DKK

Ekskl. moms og afgifter
v. samfragt med skab
6.422,00

El-tilslutning	230 / 50Hz
Optagen effekt	992 W - 5,6 A
Kølekapacitet	887 W*
Kølemiddel	R134a
*Ford. -10°C kondens.54,4°C	



+43° Tropeudførelse
75 Isolation 75 mm



Ventileret køling
Lys



Automatisk el-afrimning
Lås



Automatisk genfordampning af tøvand

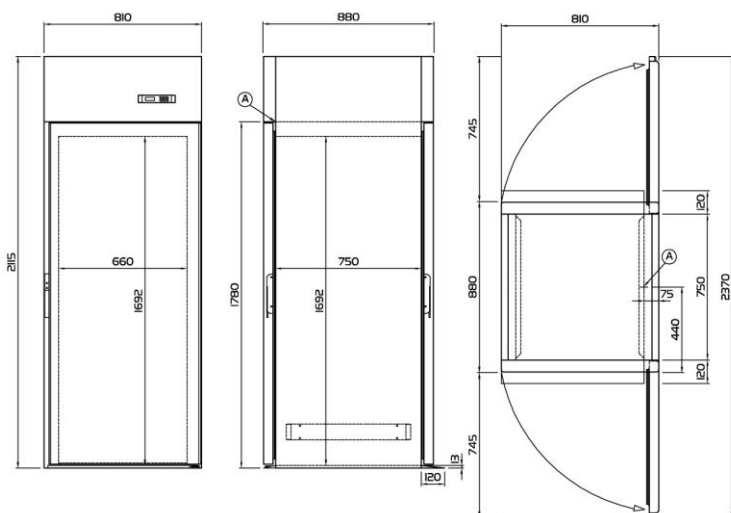

(A) POWER SUPPLY CABLE OUTLET

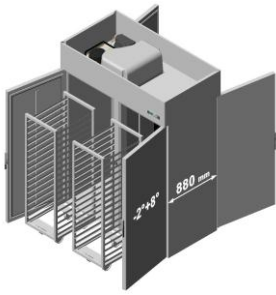

Indbygget kompressor
J170/4M
J121702004

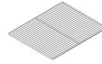

Hylder GN2/1



Vægt
200



Dimensioner
1620x880x2115

Pris i DKK

Ekskl. moms og afgifter
42.347,00

20 GN2/1

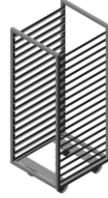

Vægt
40



Dimensioner
598x660x1630

Pris i DKK

Ekskl. moms og afgifter
v. samfragt med skab
6.422,00

El-tilslutning	230 / 50Hz
Optagen effekt	992 W - 5,6 A
Kølekapacitet	887 W*
Kølemiddel	R134a
*Ford. -10°C kondens.54,4°C	



Tropeudførelse
+43°
Isolation 75 mm



Ventileret køling
Lys



Automatisk el-afrimning
Lås



Automatisk genfordampning af tøvand

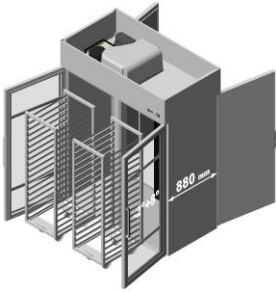

Indbygget kompressor
J170/4MV2
J121702005

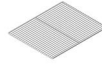

Hylder GN2/1



Vægt
220



Dimensioner
1620x880x2115

Pris i DKK

Ekskl. moms og afgifter
45.574,00

20 GN2/1

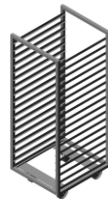

Vægt
40



Dimensioner
598x660x1630

Ekskl. moms og afgifter
v. samfragt med skab

6.422,00

El-tilslutning	230 / 50Hz
Optagen effekt	992 W - 5,6 A
Kølekapacitet	887 W*
Kølemiddel	R134a
*Ford. -10°C kondens.54,4°C	



Tropeudførelse
+43°
Isolation 75 mm



Ventileret køling
Lys



Automatisk el-afrimning
Lås



Automatisk genfordampning af tøvand

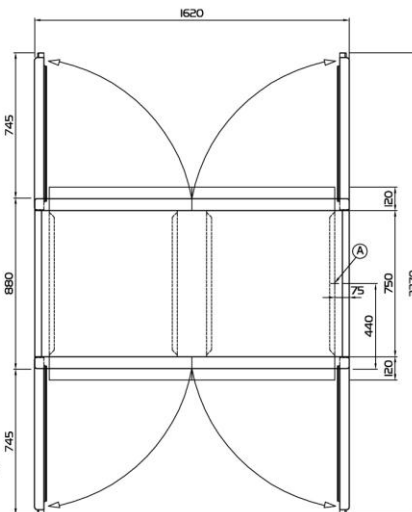
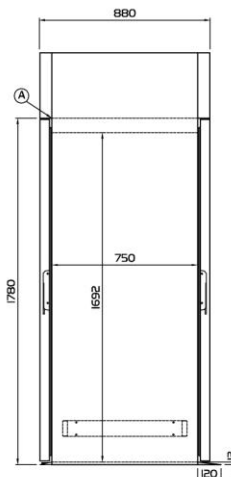
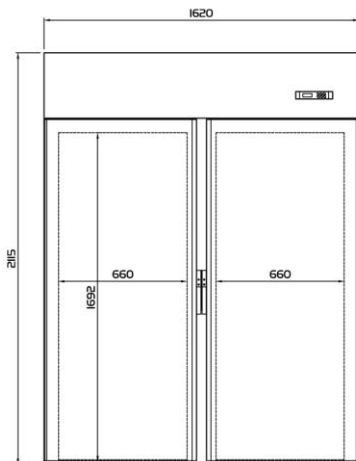

(A) POWER SUPPLY CABLE OUTLET

EGENSKABER

Udvendig/indvendig i rustfrit AISI 304 stål

Bagside og udvendig bund i galvaniseret stålplade

Isolationstykkelse 60 mm

Afrundede hjørner

Højdejusterbare ben i rustfrit stål

Selvlukkende vendbare døre, der kan åbnes 105°

Greb i PVC

Magnet tætningslister – nemme at rengøre og udskifte

Hyldevanger og hyldevinkler i rustfrit stål

Korrosionsbestandige riisan hylder GN1/1

Bordplade i forskellige udførelser (option)**Støjdæmpet kompressorrum**

Konstruerede for drift ved omgivelsestemperaturer på op til +43° C

Ventileret kulde

Coated fordampere (cataphoresis) for at modvirke tæring

Fuldt udskifteligt kølesystem

Hot gas afrimning

Genfordampning af tøvand

Elektronisk styring

Dybde 700 mm



2 dørs



Side 47

3 dørs



Side 47

4 dørs



Side 47



Dybde 700 mm – Højde 710 mm

3 dørs

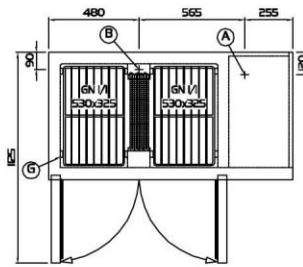
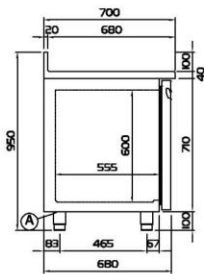
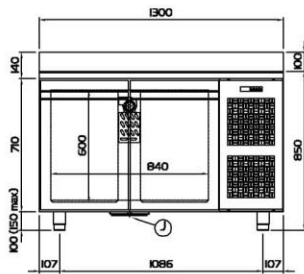

- Ⓐ POWER SUPPLY CABLE OUTLET
- Ⓑ CONDENSATION WATER DRAIN
- Ⓝ WASTE HEAT RECOVERY VAPORIZER
- Ⓓ AIRFLOW CONVEYOR
- Ⓔ RACKS PITCH



3 dørs

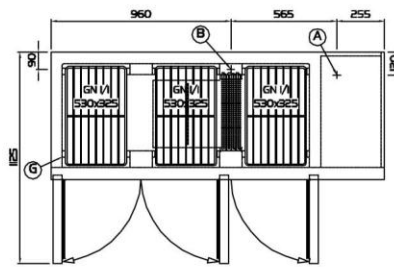
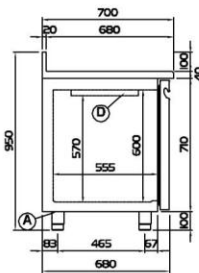
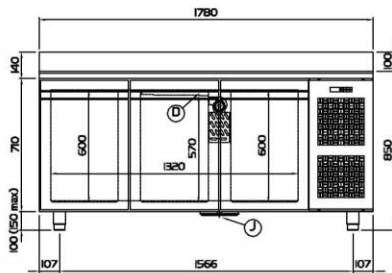

4 dørs

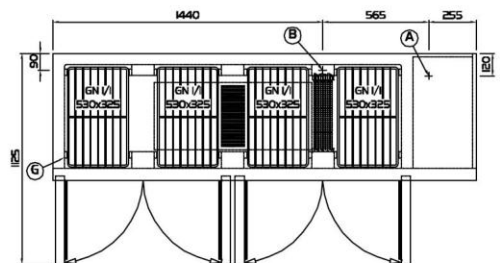
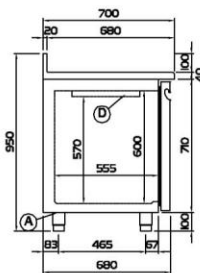
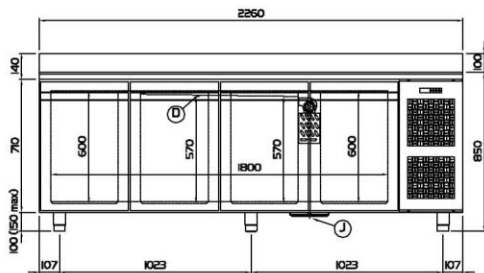

Catering

Køleborde

Smart GN1/1



						Pris i DKK
Uden bordplade	Hylder GN1/1	Hyldevinkler	Vægt	Dimensioner	Ekskl. moms og afgifter	
TS13/1ME	2	2	80	1300x680x810		15.281,00
T162000002						
Med bordplade	Hylder GN1/1	Hyldevinkler	Vægt	Dimensioner	Ekskl. moms og afgifter	
TP13/1ME	2	2	100	1300x700x850		16.471,00
T162010002						
Med bordplade m. bagkant	Hylder GN1/1	Hyldevinkler	Vægt	Dimensioner	Ekskl. moms og afgifter	
TA13/1ME	2	2	105	1300x700x950		16.630,00
T162020002						

El-tilslutning	230 / 50Hz
Optagen effekt	546 W - 3,1 A
Kølekapacitet	565 W*
Kølemiddel	R404a
*Ford. -10°C kondens.54,4°C	

Tropeudførelse Ventilert køling Hot gas afrimning Automatisk genfordampning af tøvand
 Isolation 60 mm



						Pris i DKK
Uden bordplade	Hylder GN1/1	Hyldevinkler	Vægt	Dimensioner	Ekskl. moms og afgifter	
TS17/1ME	3	3	110	1780x680x810		17.931,00
T163000002						
Med bordplade	Hylder GN1/1	Hyldevinkler	Vægt	Dimensioner	Ekskl. moms og afgifter	
TP17/1ME	3	3	130	1780x700x850		19.626,00
T163010002						
Med bordplade m. bagkant	Hylder GN1/1	Hyldevinkler	Vægt	Dimensioner	Ekskl. moms og afgifter	
TA17/1ME	3	3	135	1780x700x950		19.751,00
T163020002						

El-tilslutning	230 / 50Hz
Optagen effekt	546 W - 3,1 A
Kølekapacitet	565 W*
Kølemiddel	R404a
*Ford. -10°C kondens.54,4°C	

Tropeudførelse Ventilert køling Hot gas afrimning Automatisk genfordampning af tøvand
 Isolation 60 mm

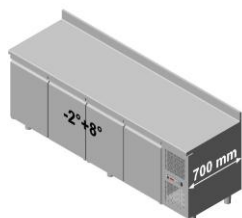

						Pris i DKK
Uden bordplade	Hylder GN1/1	Hyldevinkler	Vægt	Dimensioner	Ekskl. moms og afgifter	
TS21/1ME	4	4	140	2260x680x810		20.499,00
T164000002						
Med bordplade	Hylder GN1/1	Hyldevinkler	Vægt	Dimensioner	Ekskl. moms og afgifter	
TP21/1ME	4	4	160	2260x700x850		22.291,00
T164010002						
Med bordplade m. bagkant	Hylder GN1/1	Hyldevinkler	Vægt	Dimensioner	Ekskl. moms og afgifter	
TA21/1ME	4	4	165	2260x700x950		22.517,00
T164020002						

El-tilslutning	230 / 50Hz
Optagen effekt	546 W - 3,1 A
Kølekapacitet	565 W*
Kølemiddel	R404a
*Ford. -10°C kondens.54,4°C	

Tropeudførelse Ventilert køling Hot gas afrimning Automatisk genfordampning af tøvand
 Isolation 60 mm

Catering

Køleborde

Smart GN1/1

>Produkt	>>Type	>>>Varenummer	>>>Varenummer
Smart køleborde	2 dørs 3 dørs 4 dørs	O221325530 Plastik coated trådhylde GN1/1	O121150520 Rustfrit hyldebærere U profile, sæt af 2 stk. Type C – 505 mm

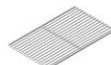
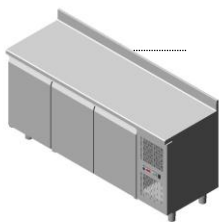

Pris i DKK (ekskl. moms)

Bestilt med bord:

179,00

I løs vægt

219,00

Ab lager



Pris i DKK (ekskl. moms)

Bestilt med bord:

164,00

I løs vægt

204,00

Ab lager

>>Type	>>>Varenummer	>>>Varenummer
2 dørs 3 dørs 4 dørs	O444000020 Rustfrit hjulsæt (4 hjul sving- og låsbare) for 2 dørs modeller	O446000020 Rustfrit hjulsæt (6 hjul sving- og låsbare) for 3/4 dørs modeller



Pris i DKK (ekskl. moms)

1.641,00



Pris i DKK (ekskl. moms)

2.461,00

>Produkt	>>Type	>>>Varenummer	>>>Pris
Smart køleborde	H710	D623012022	2/2 skuffesæt med køl (monteret på fabrikken) – H710 mm Pris i DKK (ekskl. moms) 1.956,00

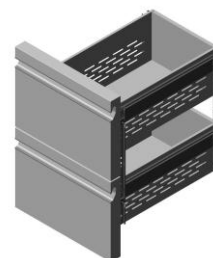
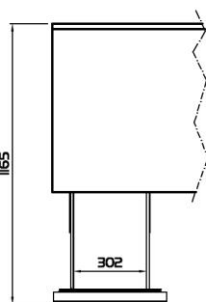
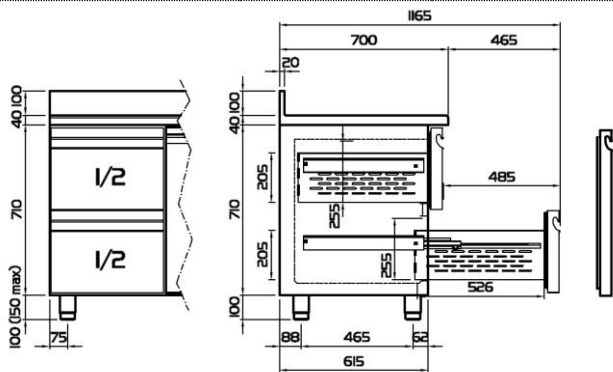

>Produkt	>>Type	>>>Varenummer	>>>Pris
Smart køleborde	H710	D623013022	3/3 skuffesæt med køl (monteret på fabrikken) – H710 mm Pris i DKK (ekskl. moms) 3.033,00

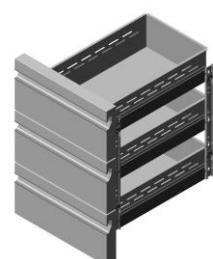
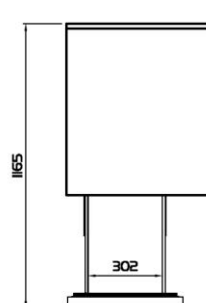
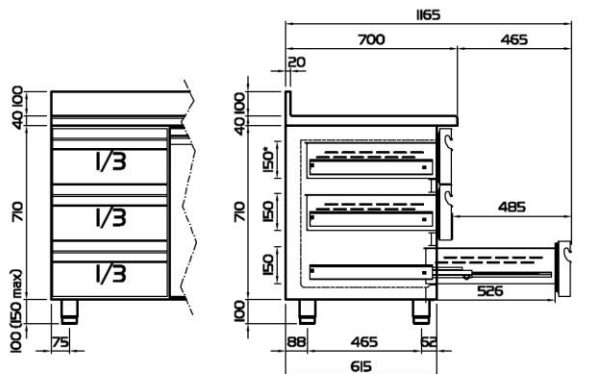

*Øverste 1/3 skuffe (3 e 4 dørs) H 100 mm

>Produkt	>>Type	>>>Varenummer	>>>Pris
Smart køleborde	H710	D623023022	1/3 + 2/3 skuffesæt med køl (monteret på fabrikken) – H710 mm Pris i DKK (ekskl. moms) 2.211,00

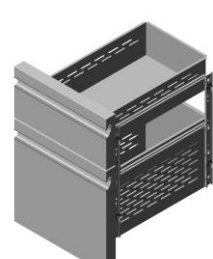
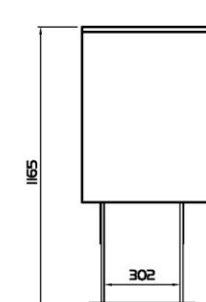
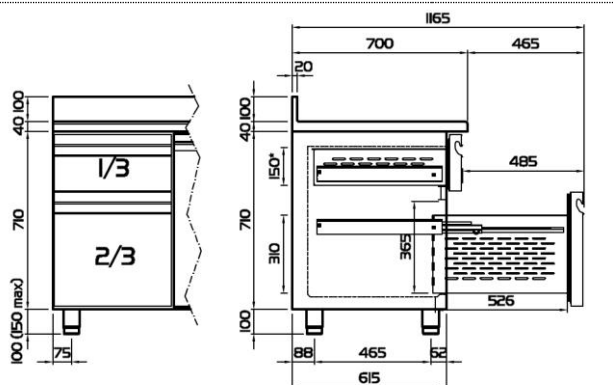

*Øverste 1/3 skuffe (3 e 4 dørs) H 100 mm

EGENSKABER

Udvendig/indvendig i rustfrit AISI 304 stål. Ink. bagside.

Isolationstykkelse 60 mm

Afrundede hjørner

Højdejusterbare ben i rustfrit stål

Selvlukkende vendbare døre, der kan åbnes 105°

Greb i rustfrit stål

Magnet tætningslister – nemme at rengøre og udskifte

Hyldeclips i PVC

Rustfri hylder 33x43

Bordplade i forskellige udførelser (option)

Støjdæmpet kompressorrum

Konstruerede for drift ved omgivelsestemperaturer på op til +43° C

Kompressorrum placeret til højre (kan uden merpris placeres til venstre efter ønske)

Ventileret kulde

Coated fordampner (cataphoresis) for at modvirke tæring

Fuldt udskifteligt kølesystem

Hot gas afrimning (for modeller med indbygget kompressor), elektrisk afrimning (for modeller for separat kompressor)

Genfordampning af tøvand

Elektronisk styring

Dybde 600 mm



1 dørs indbygget kompressor



Side 52

2 dørs indbygget kompressor



Side 52

3 dørs indbygget kompressor



Side 52

4 dørs indbygget kompressor



Side 52

1 dørs for separat kompressor



Side 53

2 dørs for separat kompressor



Side 53

3 dørs for separat kompressor



Side 53

4 dørs for separat kompressor



Side 53



Dybde 600 mm – Højde 710 mm (Højde 660 mm efter ønske)

1 dørs

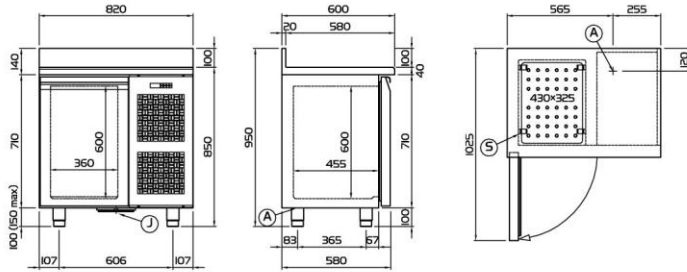

- Ⓐ POWER SUPPLY CABLE OUTLET
- Ⓔ PVC SHELF SUPPORTS
- Ⓑ CONDENSATION WATER DRAIN
- Ⓙ WASTE HEAT RECOVERY VAPORIZER
- Ⓓ AIRFLOW CONVEYOR

2 dørs

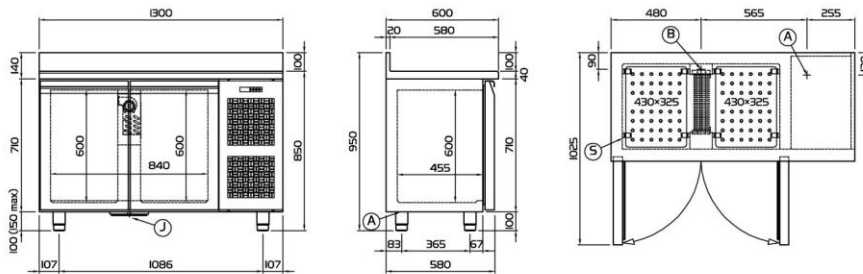

3 dørs

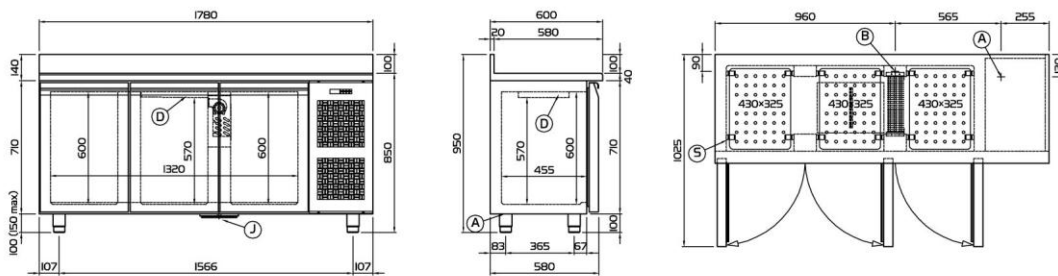

4 dørs

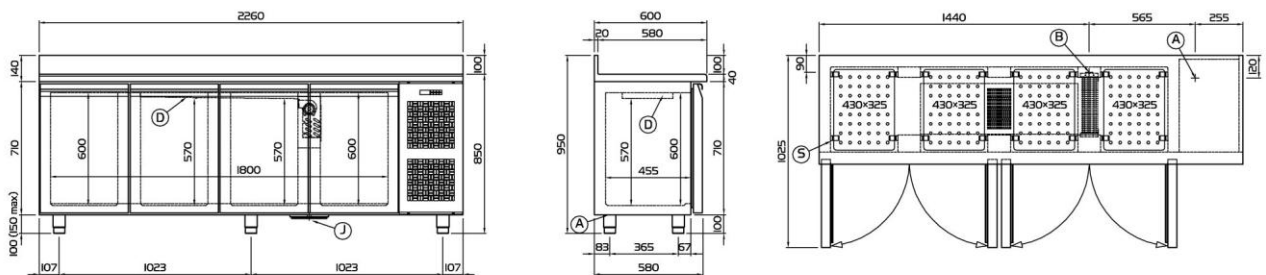

Dybde 600 mm – Højde 710 mm (H660 mm efter ønske)

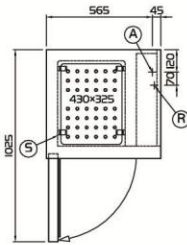
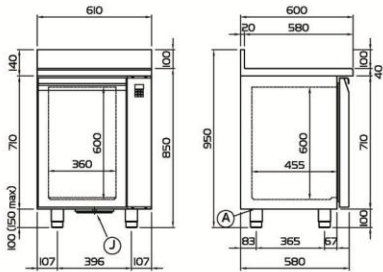

- (A) POWER SUPPLY CABLE OUTLET
- (S) PVC SHELF SUPPORTS
- (B) CONDENSATION WATER DRAIN
- (J) WASTE HEAT RECOVERY VAPORIZER
- (R) GAS PIPES OUTPUT
- (D) AIRFLOW CONVEYOR

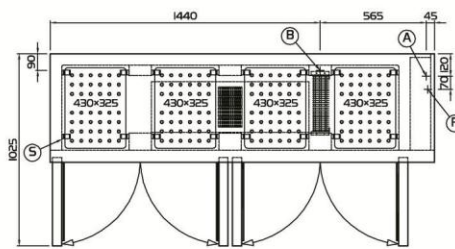
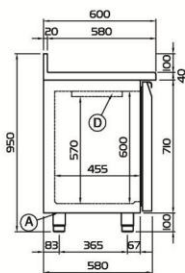
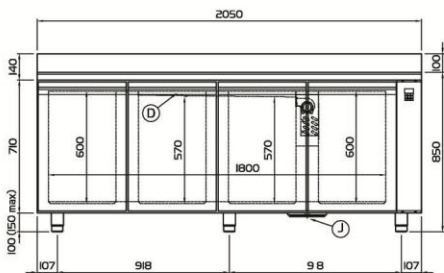
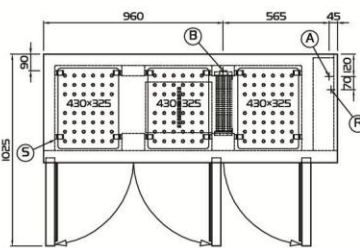
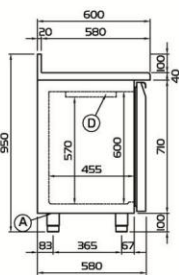
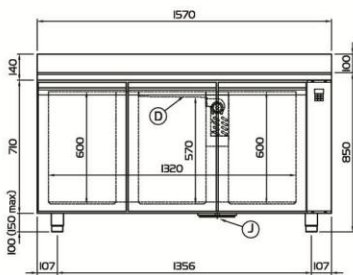
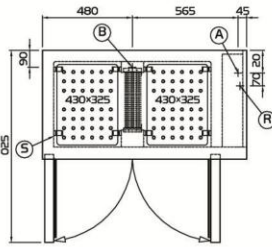
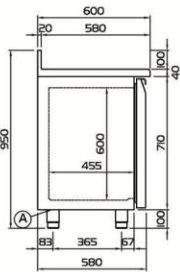
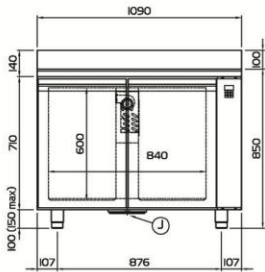

1 dørs

2 dørs

3 dørs

4 dørs



Uden bordplade	Hylde 33x43	Hyldeclips	Vægt	Dimensioner	Pris i DKK
TS09/1MQ	1	1	65	820x580x810	14.663,00
T121000002					
Med bordplade	Hylde 33x43	Hyldeclips	Vægt	Dimensioner	Pris i DKK
TP09/1MQ	1	1	85	820x600x850	15.576,00
T121010002					
Med bordplade m. bagkant	Hylde 33x43	Hyldeclips	Vægt	Dimensioner	Pris i DKK
TA09/1MQ	1	1	90	820x600x950	15.662,00
T121020002					

*Ford. -10°C kondens.54,4°C - 230 / 50Hz

Optagen effekt	344 W - 1,9 A
Kølekapacitet	368 W*
Kølemiddel	R404a



Tropeudfrelse



Ventileret køling



Hot gas afrimning



Automatisk genfordampning af tøvand



Uden bordplade	Hylde 33x43	Hyldeclips	Vægt	Dimensioner	Pris i DKK
TS13/1MQ	2	2	80	1300x580x810	16.779,00
T122000002					
Med bordplade m. bagkant	Hylde 33x43	Hyldeclips	Vægt	Dimensioner	Pris i DKK
TP13/1MQ	2	2	100	1300x600x850	17.886,00
T122010002					
Med bordplade m. bagkant	Hylde 33x43	Hyldeclips	Vægt	Dimensioner	Pris i DKK
TA13/1MQ	2	2	105	1300x600x950	18.036,00
T122020002					

*Ford. -10°C kondens.54,4°C - 230 / 50Hz

Optagen effekt	546 W - 3,1 A
Kølekapacitet	565 W*
Kølemiddel	R404a



Tropeudfrelse



Ventileret køling



Hot gas afrimning



Automatisk genfordampning af tøvand



Uden bordplade	Hylde 33x43	Hyldeclips	Vægt	Dimensioner	Pris i DKK
TS17/1MQ	3	3	110	1780x580x810	19.567,00
T123000002					
Med bordplade	Hylde 33x43	Hyldeclips	Vægt	Dimensioner	Pris i DKK
TP17/1MQ	3	3	130	1780x600x850	21.130,00
T123010002					
Med bordplade m. bagkant	Hylde 33x43	Hyldeclips	Vægt	Dimensioner	Pris i DKK
TA17/1MQ	3	3	135	1780x600x950	21.248,00
T123020002					

*Ford. -10°C kondens.54,4°C - 230 / 50Hz

Optagen effekt	546 W - 3,1 A
Kølekapacitet	565 W*
Kølemiddel	R404a



Tropeudfrelse



Ventileret køling



Hot gas afrimning



Automatisk genfordampning af tøvand

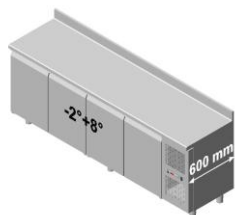

Uden bordplade	Hylde 33x43	Hyldeclips	Vægt	Dimensioner	Pris i DKK
TS21/1MQ	4	4	140	2260x580x810	22.404,00
T124000002					
Med bordplade	Hylde 33x43	Hyldeclips	Vægt	Dimensioner	Pris i DKK
TP21/1MQ	4	4	160	2260x600x850	24.064,00
T124010002					
Med bordplade m. bagkant	Hylde 33x43	Hyldeclips	Vægt	Dimensioner	Pris i DKK
TA21/1MQ	4	4	165	2260x600x950	24.273,00
T124020002					

*Ford. -10°C kondens.54,4°C - 230 / 50Hz

Optagen effekt	546 W - 3,1 A
Kølekapacitet	565 W*
Kølemiddel	R404a



Tropeudfrelse



Ventileret køling



Hot gas afrimning



Automatisk genfordampning af tøvand

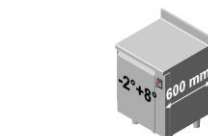

		Uden bordplade	Hylde 33x43	Hyldeclips	Vægt	Dimensioner	Pris i DKK
		TS09/1MQR	1	1	50	610x580x810	12.369,00
		T121100002					
		Med bordplade	Hylde 33x43	Hyldeclips	Vægt	Dimensioner	Ekskl. moms og afgifter
		TP09/1MQR	1	1	70	610x600x850	13.282,00
		T121110002					
		Med bordplade m. bagkant	Hylde 33x43	Hyldeclips	Vægt	Dimensioner	Ekskl. moms og afgifter
		TA09/1MQR	1	1	75	610x600x950	13.414,00
		T121120002					

**Ford. -10°C kondens.54,4°C - 230 / 50Hz

R404a Max afstand 8 m

368 W*
D181104410
Indhent pris

60 **+43°** Tropeudførelse

Ventileret køling

GAS Hot gas afrimning

Automatisk genfordampning af tøvand



		Uden bordplade	Hylde 33x43	Hyldeclips	Vægt	Dimensioner	Pris i DKK
		TS13/1MQR	2	2	60	1090x580x810	14.255,00
		T122100002					
		Med bordplade	Hylde 33x43	Hyldeclips	Vægt	Dimensioner	Ekskl. moms og afgifter
		TP13/1MQR	2	2	80	1090x600x850	15.238,00
		T122110002					
		Med bordplade m. bagkant	Hylde 33x43	Hyldeclips	Vægt	Dimensioner	Ekskl. moms og afgifter
		TA13/1MQR	2	2	85	1090x600x950	15.426,00
		T122120002					

**Ford. -10°C kondens.54,4°C - 230 / 50Hz

R404a Max afstand 8 m

565 W*
D181106110
Indhent pris

60 **+43°** Tropeudførelse

Ventileret køling

GAS Hot gas afrimning

Automatisk genfordampning af tøvand



		Uden bordplade	Hylde 33x43	Hyldeclips	Vægt	Dimensioner	Pris i DKK
		TS17/1MQR	3	3	90	1570x580x810	17.001,00
		T123100002					
		Med bordplade	Hylde 33x43	Hyldeclips	Vægt	Dimensioner	Ekskl. moms og afgifter
		TP17/1MQR	3	3	110	1570x600x850	18.282,00
		T123110002					
		Med bordplade m. bagkant	Hylde 33x43	Hyldeclips	Vægt	Dimensioner	Ekskl. moms og afgifter
		TA17/1MQR	3	3	115	1570x600x950	18.413,00
		T123120002					

**Ford. -10°C kondens.54,4°C - 230 / 50Hz

R404a Max afstand 8 m

565 W*
D181108910
Indhent pris

60 **+43°** Tropeudførelse

Ventileret køling

GAS Hot gas afrimning

Automatisk genfordampning af tøvand



		Uden bordplade	Hylde 33x43	Hyldeclips	Vægt	Dimensioner	Pris i DKK
		TS21/1MQR	4	4	120	2050x580x810	19.750,00
		T124100002					
		Med bordplade	Hylde 33x43	Hyldeclips	Vægt	Dimensioner	Ekskl. moms og afgifter
		TP21/1MQR	4	4	140	2050x600x850	21.194,00
		T124110002					
		Med bordplade m. bagkant	Hylde 33x43	Hyldeclips	Vægt	Dimensioner	Ekskl. moms og afgifter
		TA21/1MQR	4	4	145	2050x600x950	21.350,00
		T124120002					

**Ford. -10°C kondens.54,4°C - 230 / 50Hz

R404a Max afstand 8 m

565 W*
D181108910
Indhent pris

60 **+43°** Tropeudførelse

Ventileret køling

GAS Hot gas afrimning

Automatisk genfordampning af tøvand

Catering

Borde

Skuffer med køl Master 600

Dybde 600 mm

>Produkt	>>Type	>>>Varenummer		>>>Pris
Master 600 borde	H710	D623012220	2/2 skuffesæt med køl (monteret på fabrikken) – H710 mm	Pris i DKK (ekskl. moms) 2.041,00
	H660	D623012260	2/2 skuffesæt med køl (monteret på fabrikken) – H660 mm	

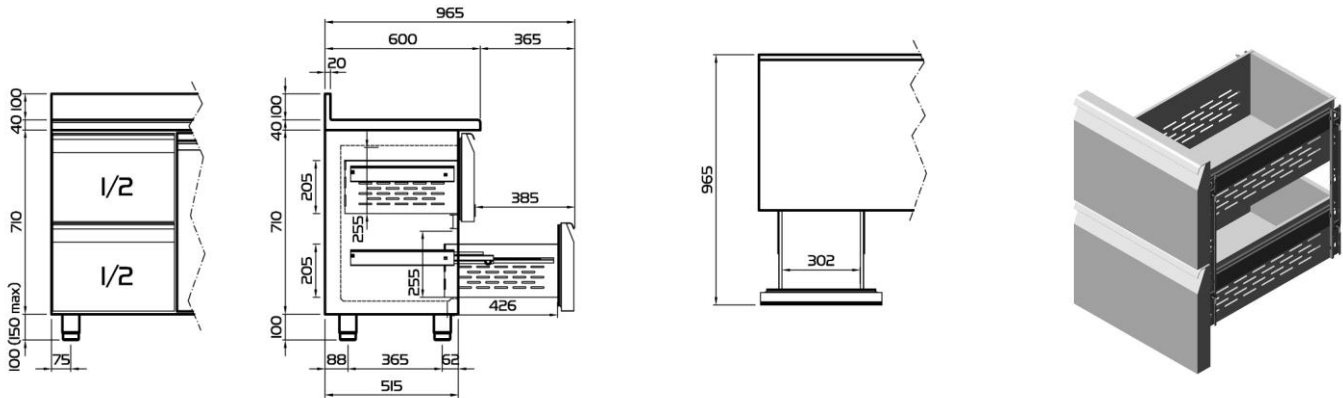

>Produkt	>>Type	>>>Varenummer		>>>Pris
Master 600 borde	H710	D623013220	3/3 skuffesæt med køl (monteret på fabrikken) – H710 mm	Pris i DKK (ekskl. moms) 3.174,00
	H660	D623013260	3/3 skuffesæt med køl (monteret på fabrikken) – H660 mm	

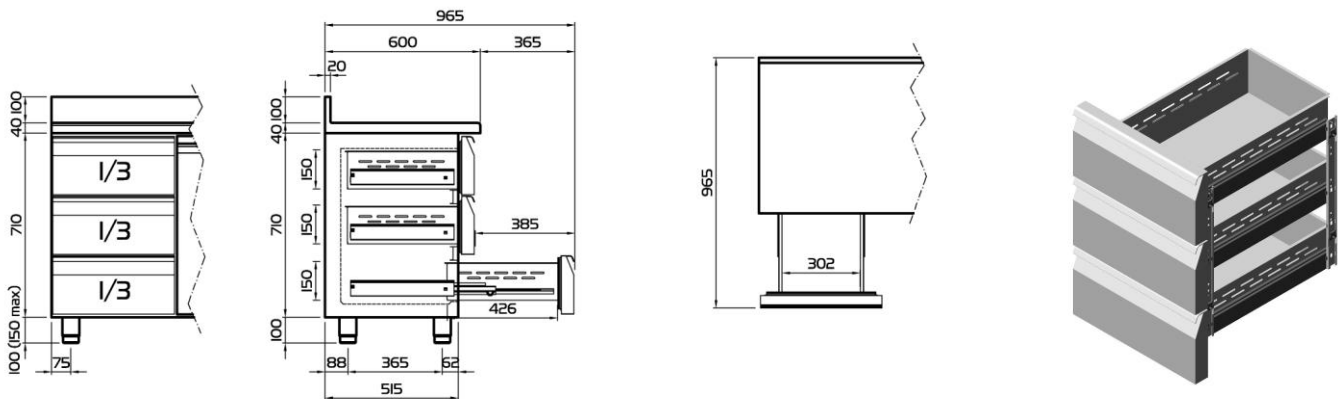

*Øverste 1/3 skuffe (3 og 4 dørs) H 100 mm

>Produkt	>>Type	>>>Varenummer		>>>Pris
Master 600 borde	H710	D623023220	1/3+2/3 skuffer med køl (monteret på fabrikken), H710 mm	Pris i DKK (ekskl. moms) 2.324,00
	H660	D623023260	1/3+2/3 skuffer med køl (monteret på fabrikken), H660 mm	

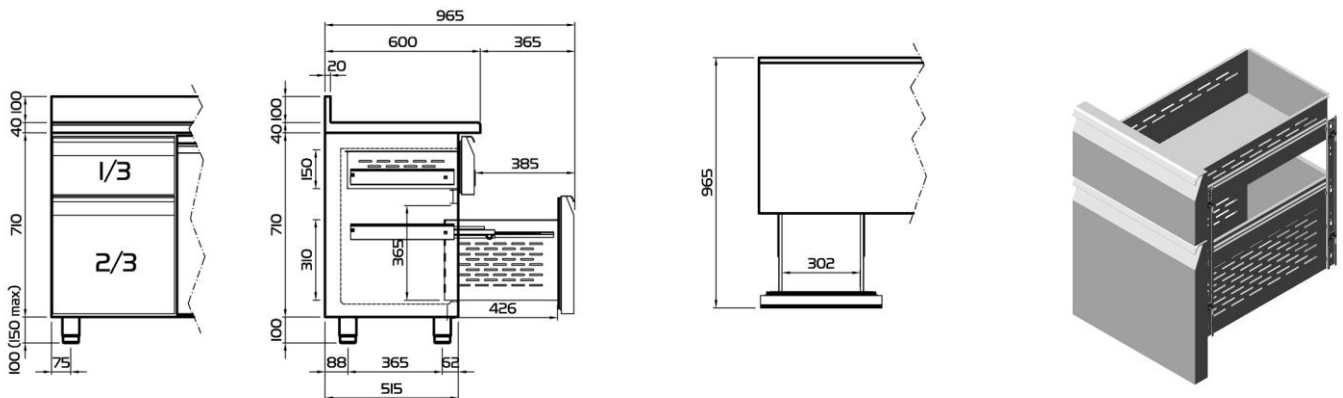

*Øverste 1/3 skuffe (3 og 4 dørs) H 100 mm

>Produkt	>>Type	>>>Varenummer	>>>Varenummer
Master 600 borde	1 dørs	O263325425 Perforeret rustfrit stål hylde 33x43	O123400020 Hyldedipsi PVC (sæt af 4 stk)
	2 dørs		
	3 dørs		
	4 dørs		
		Pris i DKK (ekskl. moms)	Pris i DKK (ekskl. moms)
		Bestilt med bord: 179,00 I løs vægt 219,00 Ab lager	Bestilt med bord: 104,00 I løs vægt 144,00 Ab lager
>Produkt	>>Type	>>>Varenummer	>>>Varenummer
	1 dørs	O444000020 Rustfrit hjulsæt (4 hjul sving- og låsbare) for 2 dørs modeller	O446000020 Rustfrit hjulsæt (6 hjul sving- og låsbare) for 3/4 dørs modeller
	2 dørs		
	3 dørs		
	4 dørs		
		Pris i DKK (ekskl. moms)	Pris i DKK (ekskl. moms)
		1.641,00	2.461,00

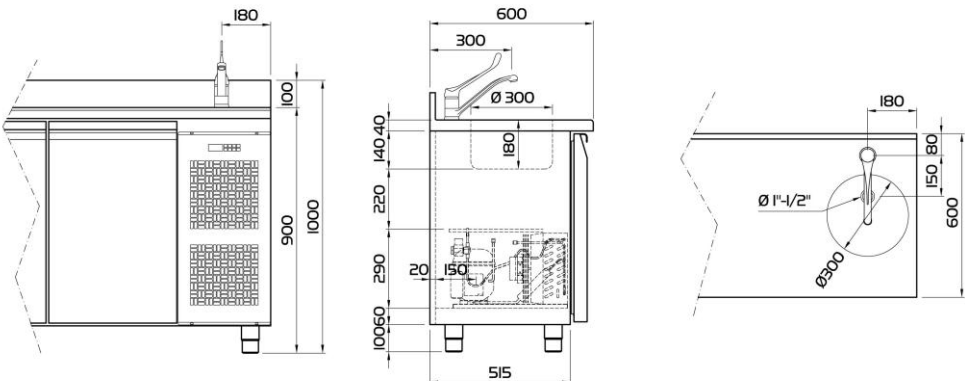
>Produkt	>>Type	>>>Varenummer
Master 600 borde	2/3/4 dørs med indbygget kompressor	Og22100020 Vask Ø 300 mm
		Pris i DKK (ekskl. moms) 4.326,00
		>>>Varenummer Og22200020 Blandingsbatteri Ø 3/4

*Afløbshul er ikke inklusiv

Dybde 700 mm

EGENSKABER

Udvendig/indvendig i rustfrit AISI 304 stål. Ink. bagside.

Isolationstykkelse 60 mm

Afrundede hjørner

Højdejusterbare ben i rustfrit stål

Selvlukkende vendbare døre, der kan åbnes 105°

Greb i rustfrit stål

Magnet tætningslister – nemme at rengøre og udskifte

Hyldevanger og hyldevinkler i rustfrit stål

Korrosionsbestandige rilsan hylde GN1/1

Bordplade i forskellige udførelser (option)**Støjdæmpet kompressorrum**

Konstruerede for drift ved omgivelsestemperaturer på op til +43° C

Kompressorrum placeret til højre (kan uden merpris placeres til venstre efter ønske)

Ventileret kulde

Coated fordampere (cataphoresis) for at modvirke tæring

Fuldt udsifteligt kølesystem

Hot gas afrimning (for modeller med indbygget kompressor), elektrisk afrimning (for

fryseborde og modeller for separat kompressor)

Genfordampning af tøvand

Elektronisk styring

**1 dørs køl (indbygget kompressor)**

Side 60

2 dørs køl (indbygget kompressor)

Side 61

3 dørs køl (indbygget kompressor)

Side 63

4 dørs køl (indbygget kompressor)

Side 65

1-4 dørs frysebord (indbygget kompressor)

Side 67

1 dørs køl (separat kompressor)

Side 68

2 dørs køl (separat kompressor)

Side 69

3 dørs køl (separat kompressor)

Side 71

4 dørs køl (separat kompressor)

Side 73

1-4 dørs frysebord (separat kompressor)

Side 75

Dybde 700 mm – Højde 710 mm (Højde 660 mm efter ønske)

1 dørs

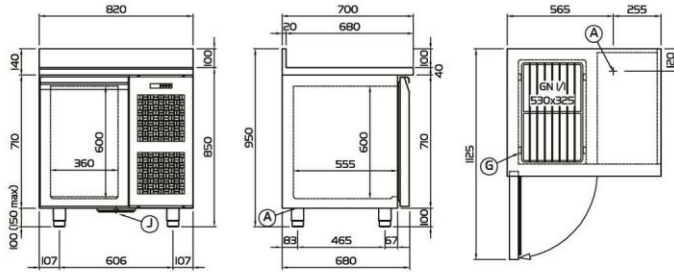

- Ⓐ POWER SUPPLY CABLE OUTLET
- Ⓑ CONDENSATION WATER DRAIN
- Ⓙ WASTE HEAT RECOVERY VAPORIZER
- ⓐ 2ND EVAPORATOR (*ONLY FREEZER VERSIONS)
- ⓓ AIRFLOW CONVEYOR
- ⓖ RACKS PITCH



2 dørs

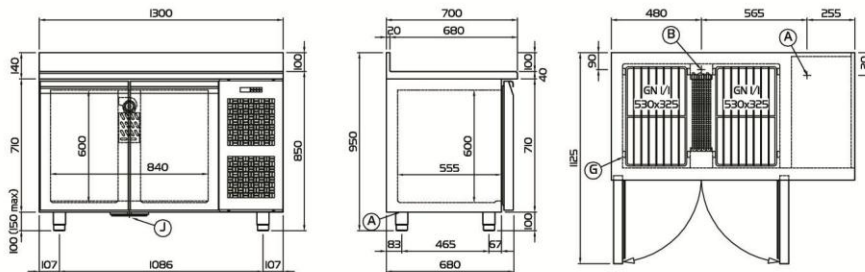

3 dørs

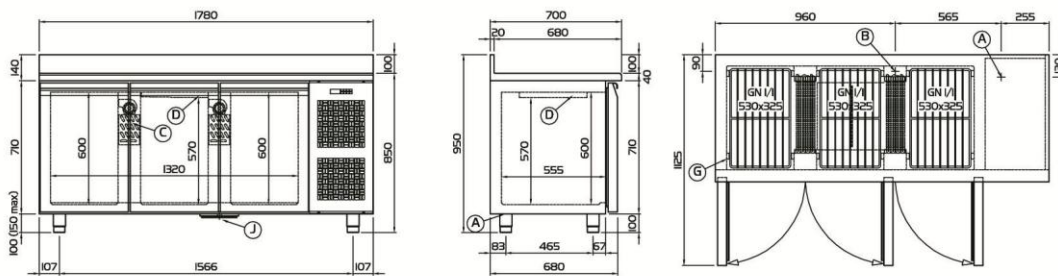

4 dørs

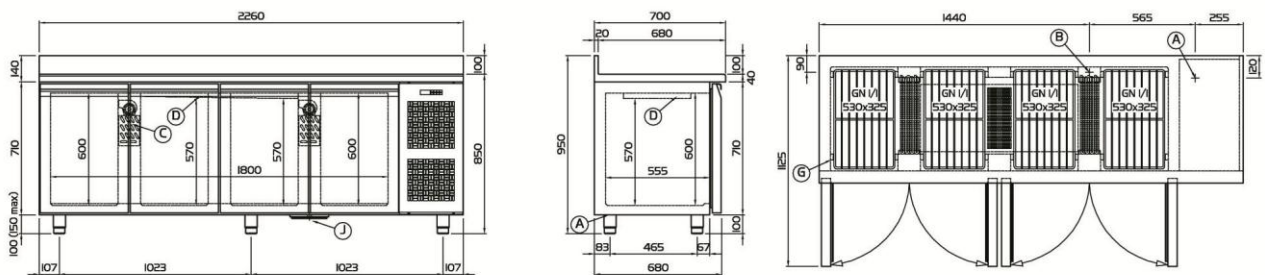

Dybde 700 mm – Højde 710 mm (Højde 660 mm efter ønske)

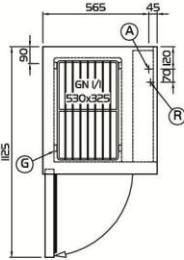
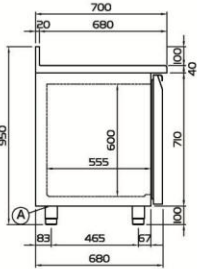
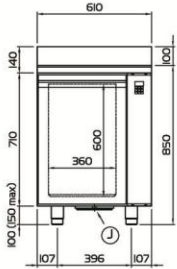

- (A) POWER SUPPLY CABLE OUTLET
- (B) CONDENSATION WATER DRAIN
- (J) WASTE HEAT RECOVERY VAPORIZER
- (R) GAS PIPES OUTPUT
- (C) 2ND EVAPORATOR (*ONLY FREEZER VERSIONS)
- (D) AIRFLOW CONVEYOR
- (G) RACKS PITCH

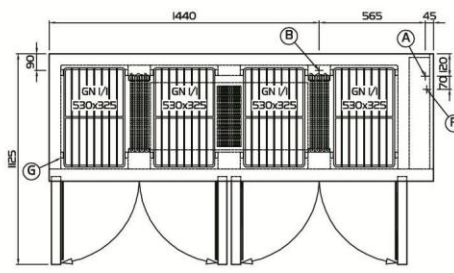
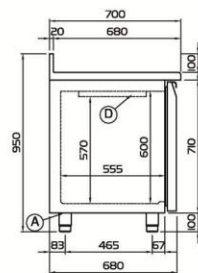
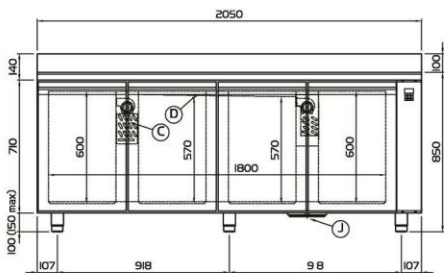
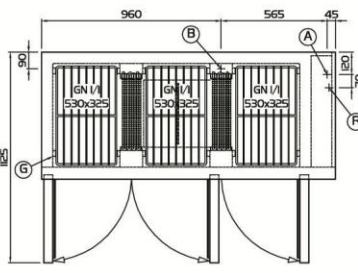
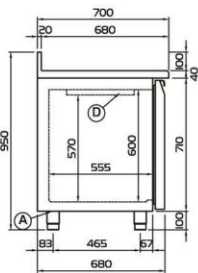
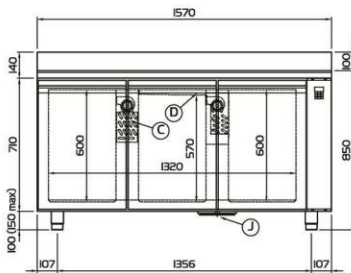
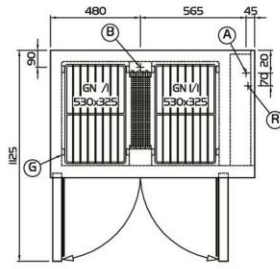
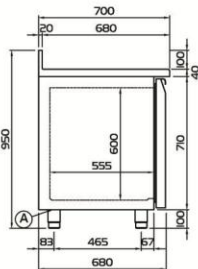
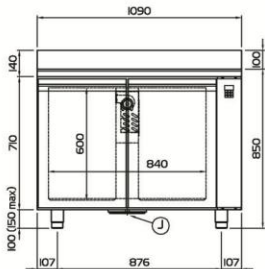

1 dørs

2 dørs

3 dørs

4 dørs

Højde 660-710 mm

Model 710 mm standard

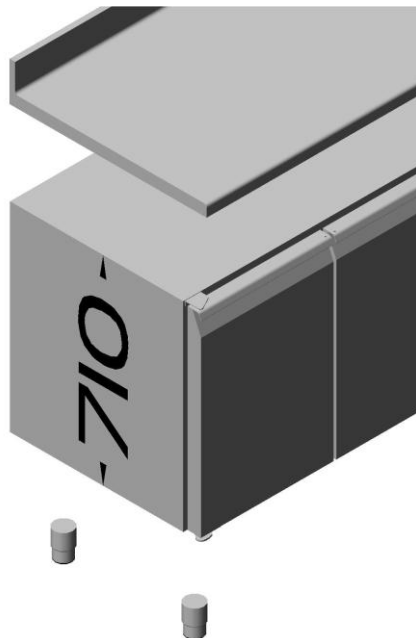

Model 660 mm (efter ønske)

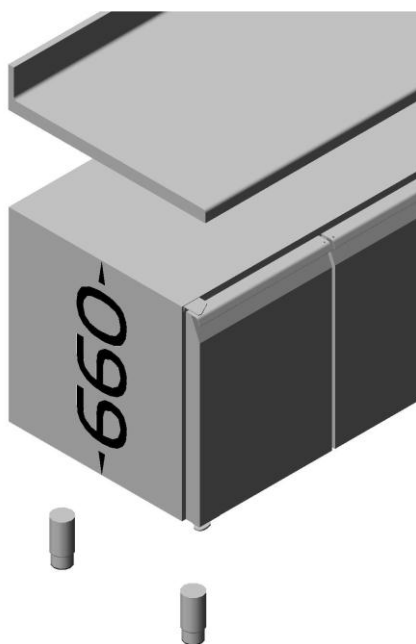



Uden bordplade	Hylde GN1/1	Hyldevinkler	Vægt	Dimensioner	Ekskl. moms og afgifter
TS09/1M	1	1	70	820x680x810	14.932,00
T141000002					
Med bordplade	Hylde GN1/1	Hyldevinkler	Vægt	Dimensioner	Ekskl. moms og afgifter
TP09/1M	1	1	90	820x700x850	15.845,00
T141010002					
Med bordplade m. bagkant	Hylde GN1/1	Hyldevinkler	Vægt	Dimensioner	Ekskl. moms og afgifter
TA09/1M	1	1	95	820x700x950	15.931,00
T141020002					

El-tilslutning	230 / 50Hz
Optagen effekt	344 W - 1,9 A
Kølekapacitet	368 W*
Kølemiddel	R404a
*Ford. -10°C kondens.54,4°C	



Tropeudførelse
Isolation 60 mm



Ventileret køling



Hot gas afrimning



Automatisk genfordampning af tøvand



Uden bordplade	Hylde GN1/1	Hyldevinkler	Vægt	Dimensioner	Ekskl. moms og afgifter
TS09/2M	-	-	75	820x680x810	16.661,00
T141000012					
Med bordplade	Hylde GN1/1	Hyldevinkler	Vægt	Dimensioner	Ekskl. moms og afgifter
TP09/2M	-	-	95	820x700x850	17.531,00
T141010012					
Med bordplade m. bagkant	Hylde GN1/1	Hyldevinkler	Vægt	Dimensioner	Ekskl. moms og afgifter
TA09/2M	-	-	100	820x700x950	17.628,00
T141020012					

El-tilslutning	230 / 50Hz
Optagen effekt	344 W - 1,9 A
Kølekapacitet	368 W*
Kølemiddel	R404a
*Ford. -10°C kondens.54,4°C	



Tropeudførelse
Isolation 60 mm



Ventileret køling



Hot gas afrimning



Automatisk genfordampning af tøvand



Uden bordplade	Hylde GN1/1	Hyldevinkler	Vægt	Dimensioner	Ekskl. moms og afgifter
TS09/3M	-	-	75	820x680x810	16.785,00
T141001002					
Med bordplade	Hylde GN1/1	Hyldevinkler	Vægt	Dimensioner	Ekskl. moms og afgifter
TP09/3M	-	-	95	820x700x850	17.660,00
T141011002					
Med bordplade m. bagkant	Hylde GN1/1	Hyldevinkler	Vægt	Dimensioner	Ekskl. moms og afgifter
TA09/3M	-	-	100	820x700x950	17.757,00
T141021002					

El-tilslutning	230 / 50Hz
Optagen effekt	344 W - 1,9 A
Kølekapacitet	368 W*
Kølemiddel	R404a
*Ford. -10°C kondens.54,4°C	



Tropeudførelse
Isolation 60 mm



Ventileret køling



Hot gas afrimning



Automatisk genfordampning af tøvand

Catering

Borde

Master GN1/1

Dybde 700 mm



Uden bordplade	Hylde GN1/1	Hyldevinkler	Vægt	Dimensioner	Ekskl. moms og afgifter
TS13/1M	2	2	90	1300x680x810	17.069,00
T14200002					
Med bordplade	Hylde GN1/1	Hyldevinkler	Vægt	Dimensioner	Ekskl. moms og afgifter
TP13/1M	2	2	110	1300x700x850	18.197,00
T142010002					
Med bordplade m. bagkant	Hylde GN1/1	Hyldevinkler	Vægt	Dimensioner	Ekskl. moms og afgifter
TA13/1M	2	2	115	1300x700x950	18.347,00
T142020002					

El-tilslutning	230 / 50Hz
Optagen effekt	546 W - 3,1 A
Kølekapacitet	565 W*
Kølemiddel	R404a
*Ford. -10°C kondens.54,4°C	



Tropeduførelse
+43°
Isolation 60 mm



Ventileret køling



Hot gas afrimning



Automatisk genfordampning af tøvand

Pris i DKK



Uden bordplade	Hylde GN1/1	Hyldevinkler	Vægt	Dimensioner	Ekskl. moms og afgifter
TS13/2M	1	1	95	1300x680x810	18.793,00
T142000012					
Med bordplade	Hylde GN1/1	Hyldevinkler	Vægt	Dimensioner	Ekskl. moms og afgifter
TP13/2M	1	1	115	1300x700x850	19.889,00
T142010012					
Med bordplade m. bagkant	Hylde GN1/1	Hyldevinkler	Vægt	Dimensioner	Ekskl. moms og afgifter
TA13/2M	1	1	120	1300x700x950	20.044,00
T142020012					

El-tilslutning	230 / 50Hz
Optagen effekt	546 W - 3,1 A
Kølekapacitet	565 W*
Kølemiddel	R404a
*Ford. -10°C kondens.54,4°C	



Tropeduførelse
+43°
Isolation 60 mm



Ventileret køling



Hot gas afrimning



Automatisk genfordampning af tøvand

Pris i DKK



Uden bordplade	Hylde GN1/1	Hyldevinkler	Vægt	Dimensioner	Ekskl. moms og afgifter
TS13/3M	1	1	95	1300x680x810	18.847,00
T142001002					
Med bordplade	Hylde GN1/1	Hyldevinkler	Vægt	Dimensioner	Ekskl. moms og afgifter
TP13/3M	1	1	115	1300x700x850	20.044,00
T142011002					
Med bordplade m. bagkant	Hylde GN1/1	Hyldevinkler	Vægt	Dimensioner	Ekskl. moms og afgifter
TA13/3M	1	1	120	1300x700x950	21.141,00
T142021002					

El-tilslutning	230 / 50Hz
Optagen effekt	546 W - 3,1 A
Kølekapacitet	565 W*
Kølemiddel	R404a
*Ford. -10°C kondens.54,4°C	



Tropeduførelse
+43°
Isolation 60 mm



Ventileret køling



Hot gas afrimning



Automatisk genfordampning af tøvand

Pris i DKK

Catering

Borde

Master GN1/1

Dybde 700 mm



						Pris i DKK
Uden bordplade	Hylder GN1/1	Hyldevinkler	Vægt	Dimensioner	Ekskl. moms og afgifter	
TS13/4M	-	-	95	1300x680x810		20.490,00
T14200022						
Med bordplade	Hylder GN1/1	Hyldevinkler	Vægt	Dimensioner	Ekskl. moms og afgifter	
TP13/4M	-	-	115	1300x700x850		21.618,00
T142010022						
Med bordplade m. bagkant	Hylder GN1/1	Hyldevinkler	Vægt	Dimensioner	Ekskl. moms og afgifter	
TA13/4M	-	-	120	1300x700x950		21.741,00
T142020022						

El-tilslutning	230 / 50Hz
Optagen effekt	546 W - 3,1 A
Kølekapacitet	565 W*
Kølemiddel	R404a
*Ford. -10°C kondens.54,4°C	



Tropeudførelse
Isolation 60 mm



Ventileret køling



Hot gas afrimning



Automatisk genfordampning af tøvand



						Pris i DKK
Uden bordplade	Hylder GN1/1	Hyldevinkler	Vægt	Dimensioner	Ekskl. moms og afgifter	
TS13/5M	-	-	95	1300x680x810		20.614,00
T142001012						
Med bordplade	Hylder GN1/1	Hyldevinkler	Vægt	Dimensioner	Ekskl. moms og afgifter	
TP13/5M	-	-	115	1300x700x850		21.741,00
T142011012						
Med bordplade m. bagkant	Hylder GN1/1	Hyldevinkler	Vægt	Dimensioner	Ekskl. moms og afgifter	
TA13/5M	-	-	120	1300x700x950		21.865,00
T142021012						

El-tilslutning	230 / 50Hz
Optagen effekt	546 W - 3,1 A
Kølekapacitet	565 W*
Kølemiddel	R404a
*Ford. -10°C kondens.54,4°C	



Tropeudførelse
Isolation 60 mm



Ventileret køling



Hot gas afrimning



Automatisk genfordampning af tøvand



						Pris i DKK
Uden bordplade	Hylder GN1/1	Hyldevinkler	Vægt	Dimensioner	Ekskl. moms og afgifter	
TS13/6M	-	-	95	1300x680x810		21.521,00
T142000112						
Med bordplade	Hylder GN1/1	Hyldevinkler	Vægt	Dimensioner	Ekskl. moms og afgifter	
TP13/6M	-	-	115	1300x700x850		22.654,00
T142010112						
Med bordplade m. bagkant	Hylder GN1/1	Hyldevinkler	Vægt	Dimensioner	Ekskl. moms og afgifter	
TA13/6M	-	-	120	1300x700x950		22.810,00
T142020112						

El-tilslutning	230 / 50Hz
Optagen effekt	546 W - 3,1 A
Kølekapacitet	565 W*
Kølemiddel	R404a
*Ford. -10°C kondens.54,4°C	



Tropeudførelse
Isolation 60 mm



Ventileret køling



Hot gas afrimning



Automatisk genfordampning af tøvand

Catering

Borde

Master GN1/1

700 mm



						Pris i DKK
Uden bordplade	Hylder GN1/1	Hyldevinkler	Vægt	Dimensioner	Ekskl. moms og afgifter	
TS17/1M	3	3	120	1780x680x810		19.889,00
T143000002						
Med bordplade	Hylder GN1/1	Hyldevinkler	Vægt	Dimensioner	Ekskl. moms og afgifter	
TP17/1M	3	3	145	1780x700x850		21.495,00
T143010002						
Med bordplade m. bagkant	Hylder GN1/1	Hyldevinkler	Vægt	Dimensioner	Ekskl. moms og afgifter	
TA17/1M	3	3	150	1780x700x950		21.613,00
T143020002						

El-tilslutning	230 / 50Hz
Optagen effekt	546 W - 3,1 A
Kølekapacitet	565 W*
Kølemiddel	R404a
*Ford. -10°C kondens.54,4°C	



Trapeudførelse
+43°
Isolation 60 mm



Ventileret køling



Hot gas afrimning



Automatisk genfordampning af tøvand

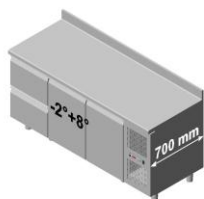

						Pris i DKK
Uden bordplade	Hylder GN1/1	Hyldevinkler	Vægt	Dimensioner	Ekskl. moms og afgifter	
TS17/2M	2	2	125	1780x680x810		22.816,00
T143000012						
Med bordplade	Hylder GN1/1	Hyldevinkler	Vægt	Dimensioner	Ekskl. moms og afgifter	
TP17/2M	2	2	150	1780x700x850		23.187,00
T143010012						
Med bordplade m. bagkant	Hylder GN1/1	Hyldevinkler	Vægt	Dimensioner	Ekskl. moms og afgifter	
TA17/2M	2	2	155	1780x700x950		23.337,00
T143020012						

El-tilslutning	230 / 50Hz
Optagen effekt	546 W - 3,1 A
Kølekapacitet	565 W*
Kølemiddel	R404a
*Ford. -10°C kondens.54,4°C	



Trapeudførelse
+43°
Isolation 60 mm



Ventileret køling



Hot gas afrimning



Automatisk genfordampning af tøvand



						Pris i DKK
Uden bordplade	Hylder GN1/1	Hyldevinkler	Vægt	Dimensioner	Ekskl. moms og afgifter	
TS17/3M	1	1	125	1780x680x810		23.434,00
T143000022						
Med bordplade	Hylder GN1/1	Hyldevinkler	Vægt	Dimensioner	Ekskl. moms og afgifter	
TP17/3M	1	1	150	1780x700x850		24.878,00
T143010022						
Med bordplade m. bagkant	Hylder GN1/1	Hyldevinkler	Vægt	Dimensioner	Ekskl. moms og afgifter	
TA17/3M	1	1	155	1780x700x950		25.034,00
T143020022						

El-tilslutning	230 / 50Hz
Optagen effekt	546 W - 3,1 A
Kølekapacitet	565 W*
Kølemiddel	R404a
*Ford. -10°C kondens.54,4°C	



Trapeudførelse
+43°
Isolation 60 mm



Ventileret køling



Hot gas afrimning



Automatisk genfordampning af tøvand

Catering

Borde

Master GN1/1

Dybde 700 mm



Uden bordplade	Hylder GN1/1	Hylddevinkler	Vægt	Dimensioner	Pris i DKK
TS17/4M	1	1	125	1780x680x810	24.658,00
T143000112					
Med bordplade	Hylder GN1/1	Hylddevinkler	Vægt	Dimensioner	Pris i DKK
TP17/4M	1	1	150	1780x700x850	25.791,00
T143010112					
Med bordplade m. bagkant	Hylder GN1/1	Hylddevinkler	Vægt	Dimensioner	Pris i DKK
TA17/4M	1	1	155	1780x700x950	25.920,00
T143020112					

El-tilslutning	230 / 50Hz
Optagen effekt	546 W - 3,1 A
Kølekapacitet	565 W*
Kølemiddel	R404a
*Ford. -10°C kondens.54,4°C	



Tropeduførelse
+43°
Isolation 60 mm



Ventileret køling



Hot gas afrimning



Automatisk genfordampning af tøvand

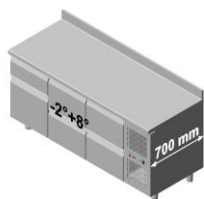

Uden bordplade	Hylder GN1/1	Hylddevinkler	Vægt	Dimensioner	Pris i DKK
TS17/5M	-	-	130	1780x680x810	25.507,00
T143001022					
Med bordplade	Hylder GN1/1	Hylddevinkler	Vægt	Dimensioner	Pris i DKK
TP17/5M	-	-	155	1780x700x850	26.704,00
T143011022					
Med bordplade m. bagkant	Hylder GN1/1	Hylddevinkler	Vægt	Dimensioner	Pris i DKK
TA17/5M	-	-	160	1780x700x950	26.919,00
T143021022					

El-tilslutning	230 / 50Hz
Optagen effekt	546 W - 3,1 A
Kølekapacitet	565 W*
Kølemiddel	R404a
*Ford. -10°C kondens.54,4°C	



Tropeduførelse
+43°
Isolation 60 mm



Ventileret køling



Hot gas afrimning



Automatisk genfordampning af tøvand

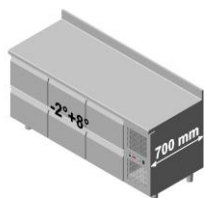

Uden bordplade	Hylder GN1/1	Hylddevinkler	Vægt	Dimensioner	Pris i DKK
TS17/6M	-	-	135	1780x680x810	25.260,00
T143000032					
Med bordplade	Hylder GN1/1	Hylddevinkler	Vægt	Dimensioner	Pris i DKK
TP17/6M	-	-	160	1780x700x850	26.635,00
T143010032					
Med bordplade m. bagkant	Hylder GN1/1	Hylddevinkler	Vægt	Dimensioner	Pris i DKK
TA17/6M	-	-	165	1780x700x950	26.828,00
T143020032					

El-tilslutning	230 / 50Hz
Optagen effekt	546 W - 3,1 A
Kølekapacitet	565 W*
Kølemiddel	R404a
*Ford. -10°C kondens.54,4°C	



Tropeduførelse
+43°
Isolation 60 mm



Ventileret køling



Hot gas afrimning



Automatisk genfordampning af tøvand

Catering

Borde

Master GN1/1

Byde 700 mm

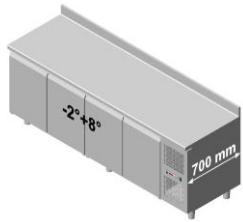

Uden bordplade	Hylder GN1/1	Hyldevinkler	Vægt	Dimensioner	Pris i DKK
TS21/1M	4	4	150	2260x680x810	22.780,00
T14400002					

Med bordplade	Hylder GN1/1	Hyldevinkler	Vægt	Dimensioner	Pris i DKK
TP21/1M	4	4	175	2260x700x850	24.477,00
T144010002					

Med bordplade m. bagkant	Hylder GN1/1	Hyldevinkler	Vægt	Dimensioner	Pris i DKK
TA21/1M	4	4	180	2260x700x950	24.692,00
T144020002					

El-tilslutning	230 / 50Hz
Optagen effekt	546 W - 3,1 A
Kølekapacitet	565 W*
Kølemiddel	R404a
*Ford. -10°C kondens.54,4°C	

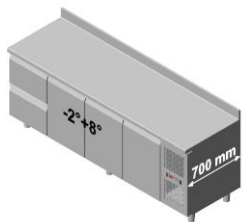
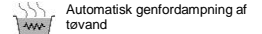
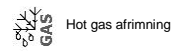

Uden bordplade	Hylder GN1/1	Hyldevinkler	Vægt	Dimensioner	Pris i DKK
TS21/2M	3	3	155	2260x680x810	24.451,00
T144000012					

Med bordplade	Hylder GN1/1	Hyldevinkler	Vægt	Dimensioner	Pris i DKK
TP21/2M	3	3	180	2260x700x850	26.142,00
T144010012					

Med bordplade m. bagkant	Hylder GN1/1	Hyldevinkler	Vægt	Dimensioner	Pris i DKK
TA21/2M	3	3	185	2260x700x950	26.362,00
T144020012					

El-tilslutning	230 / 50Hz
Optagen effekt	546 W - 3,1 A
Kølekapacitet	565 W*
Kølemiddel	R404a
*Ford. -10°C kondens.54,4°C	

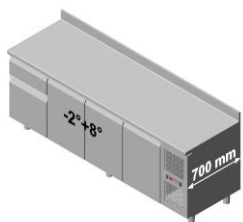
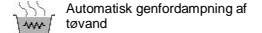
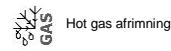
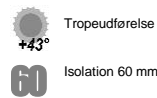

Uden bordplade	Hylder GN1/1	Hyldevinkler	Vægt	Dimensioner	Pris i DKK
TS21/3M	3	3	155	2260x680x810	24.601,00
T144001002					

Med bordplade	Hylder GN1/1	Hyldevinkler	Vægt	Dimensioner	Pris i DKK
TP21/3M	3	3	180	2260x700x850	26.336,00
T144011002					

Med bordplade m. bagkant	Hylder GN1/1	Hyldevinkler	Vægt	Dimensioner	Pris i DKK
TA21/3M	3	3	185	2260x700x950	26.518,00
T144021002					

El-tilslutning	230 / 50Hz
Optagen effekt	546 W - 3,1 A
Kølekapacitet	565 W*
Kølemiddel	R404a
*Ford. -10°C kondens.54,4°C	

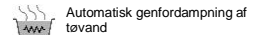
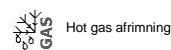

Catering

Borde

Master GN1/1

Byde 700 mm

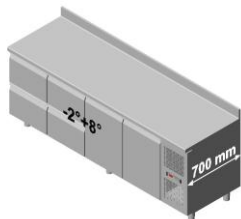

						Pris i DKK
Uden bordplade	Hylder GN1/1	Hylddevinkler	Vægt	Dimensioner	Ekskl. moms og afgifter	
TS21/4M	2	2	160	2260x680x810		26.454,00
T14400022						
Med bordplade	Hylder GN1/1	Hylddevinkler	Vægt	Dimensioner	Ekskl. moms og afgifter	
TP21/4M	2	2	185	2260x700x850		28.118,00
T144010022						
Med bordplade m. bagkant	Hylder GN1/1	Hylddevinkler	Vægt	Dimensioner	Ekskl. moms og afgifter	
TA21/4M	2	2	190	2260x700x950		28.333,00
T144020022						

El-tilslutning	230 / 50Hz
Optagen effekt	546 W - 3,1 A
Kølekapacitet	565 W*
Kølemiddel	R404a
*Ford. -10°C kondens.54,4°C	



Tropeudførelse
Isolation 60 mm



Ventileret køling



Hot gas afrimning



Automatisk genfordampning af tøvand

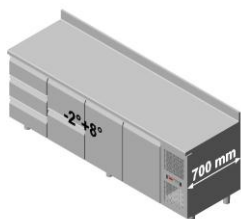

						Pris i DKK
Uden bordplade	Hylder GN1/1	Hylddevinkler	Vægt	Dimensioner	Ekskl. moms og afgifter	
TS21/5M	2	2	160	2260x680x810		27.393,00
T144000112						
Med bordplade	Hylder GN1/1	Hylddevinkler	Vægt	Dimensioner	Ekskl. moms og afgifter	
TP21/5M	2	2	185	2260x700x850		29.026,00
T144010112						
Med bordplade m. bagkant	Hylder GN1/1	Hylddevinkler	Vægt	Dimensioner	Ekskl. moms og afgifter	
TA21/5M	2	2	190	2260x700x950		29.278,00
T144020112						

El-tilslutning	230 / 50Hz
Optagen effekt	546 W - 3,1 A
Kølekapacitet	565 W*
Kølemiddel	R404a
*Ford. -10°C kondens.54,4°C	



Tropeudførelse
Isolation 60 mm



Ventileret køling



Hot gas afrimning



Automatisk genfordampning af tøvand

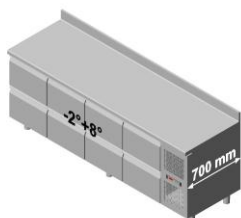

						Pris i DKK
Uden bordplade	Hylder GN1/1	Hylddevinkler	Vægt	Dimensioner	Ekskl. moms og afgifter	
TS21/6M	-	-	180	2260x680x810		29.687,00
T144000042						
Med bordplade	Hylder GN1/1	Hylddevinkler	Vægt	Dimensioner	Ekskl. moms og afgifter	
TP21/6M	-	-	205	2260x700x850		31.314,00
T144010042						
Med bordplade m. bagkant	Hylder GN1/1	Hylddevinkler	Vægt	Dimensioner	Ekskl. moms og afgifter	
TA21/6M	-	-	210	2260x700x950		31.539,00
T144020042						

El-tilslutning	230 / 50Hz
Optagen effekt	546 W - 3,1 A
Kølekapacitet	565 W*
Kølemiddel	R404a
*Ford. -10°C kondens.54,4°C	



Tropeudførelse
Isolation 60 mm



Ventileret køling



Hot gas afrimning



Automatisk genfordampning af tøvand

Catering

Borde

Master GN1/1 frys

Dybde 700 mm



Uden bordplade	Hylde GN1/1	Hyldevinkler	Vægt	Dimensioner	Pris i DKK
TS09/1B	1	1	70	820x680x810	16.317,00
T141000004					
Med bordplade	Hylde GN1/1	Hyldevinkler	Vægt	Dimensioner	Ekskl. moms og afgifter
TP09/1B	1	1	90	820x700x850	17.230,00
T141010004					
Med bordplade m. bagkant	Hylde GN1/1	Hyldevinkler	Vægt	Dimensioner	Ekskl. moms og afgifter
TA09/1B	1	1	95	820x700x950	17.316,00
T141020004					

*Ford. -23,3°C kondens.54,4°C - 230 / 50Hz

El-tilslutning	513 W - 3 A
Kølekapacitet	464 W*
Kølemiddel	R404a



Tropeudførelse



Ventileret køling



Elektrisk afrimning



Automatisk genfordampning af tøvand

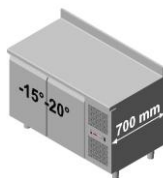

Uden bordplade	Hylde GN1/1	Hyldevinkler	Vægt	Dimensioner	Pris i DKK
TS13/1B	2	2	90	1300x680x810	19.604,00
T142000004					
Med bordplade	Hylde GN1/1	Hyldevinkler	Vægt	Dimensioner	Ekskl. moms og afgifter
TP13/1B	2	2	110	1300x700x850	20.732,00
T142010004					
Med bordplade m. bagkant	Hylde GN1/1	Hyldevinkler	Vægt	Dimensioner	Ekskl. moms og afgifter
TA13/1B	2	2	115	1300x700x950	20.893,00
T142020004					

*Ford. -23,3°C kondens.54,4°C - 230 / 50Hz

El-tilslutning	731 W - 4,1 A
Kølekapacitet	616 W*
Kølemiddel	R404a



Tropeudførelse



Ventileret køling



Elektrisk afrimning



Automatisk genfordampning af tøvand

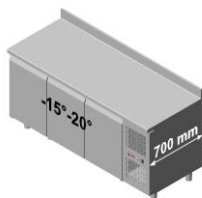

Uden bordplade	Hylde GN1/1	Hyldevinkler	Vægt	Dimensioner	Pris i DKK
TS17/1B	3	3	120	1780x680x810	23.251,00
T143000004					
Med bordplade	Hylde GN1/1	Hyldevinkler	Vægt	Dimensioner	Ekskl. moms og afgifter
TP17/1B	3	3	145	1780x700x850	24.696,00
T143010004					
Med bordplade m. bagkant	Hylde GN1/1	Hyldevinkler	Vægt	Dimensioner	Ekskl. moms og afgifter
TA17/1B	3	3	150	1780x700x950	24.819,00
T143020004					

*Ford. -23,3°C kondens.54,4°C - 230 / 50Hz

El-tilslutning	896 W - 5 A
Optagen effekt	782 W*
Kølekapacitet	R404a



Tropeudførelse



Ventileret køling



Elektrisk afrimning



Automatisk genfordampning af tøvand

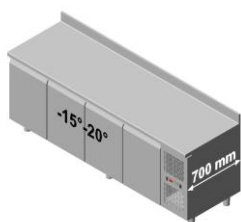

Uden bordplade	Hylde GN1/1	Hyldevinkler	Vægt	Dimensioner	Pris i DKK
TS21/1B	4	4	150	2260x680x810	26.051,00
T144000004					
Med bordplade	Hylde GN1/1	Hyldevinkler	Vægt	Dimensioner	Ekskl. moms og afgifter
TP21/1B	4	4	175	2260x700x850	27.866,00
T144010004					
Med bordplade m. bagkant	Hylde GN1/1	Hyldevinkler	Vægt	Dimensioner	Ekskl. moms og afgifter
TA21/1B	4	4	180	2260x700x950	28.086,00
T144020004					

*Ford. -23,3°C kondens.54,4°C - 230 / 50Hz

El-tilslutning	1098 W - 6,1 A
Optagen effekt	935 W*
Kølekapacitet	R404a



Tropeudførelse



Ventileret køling



Elektrisk afrimning



Automatisk genfordampning af tøvand



						Pris i DKK
Uden bordplade	Hylder GN1/1	Hylddevinkler	Vægt	Dimensioner	Ekskl. moms og afgifter	
TS09/1MR	1	1	60	610x680x810	12.880,00	
T141100002						
Med bordplade	Hylder GN1/1	Hylddevinkler	Vægt	Dimensioner	Ekskl. moms og afgifter	
TP09/1MR	1	1	70	610x700x850	13.793,00	
T141110002						
Med bordplade m. bagkant	Hylder GN1/1	Hylddevinkler	Vægt	Dimensioner	Ekskl. moms og afgifter	
TA09/1MR	1	1	75	610x700x950	13.879,00	
T141120002						

*Ford. -10°C kondens.54,4°C - 230 / 50Hz

Kompressoraggregat

Kølekapacitet **368 W***



R404a
Max afstand
8 m

Dim. 430x450x300

D181104410

Indhent pris



Tropeudførelse



Ventileret køling



Elektrisk afrimning



Automatisk genfordampning af tøvand



Isolation 60 mm



Pris i DKK

						Pris i DKK
Uden bordplade	Hylder GN1/1	Hylddevinkler	Vægt	Dimensioner	Ekskl. moms og afgifter	
TS09/2MR	-	-	65	610x680x810	14.610,00	
T141100012						
Med bordplade	Hylder GN1/1	Hylddevinkler	Vægt	Dimensioner	Ekskl. moms og afgifter	
TP09/2MR	-	-	75	610x700x850	15.480,00	
T141110012						
Med bordplade m. bagkant	Hylder GN1/1	Hylddevinkler	Vægt	Dimensioner	Ekskl. moms og afgifter	
TA09/2MR	-	-	80	610x700x950	15.576,00	
T141120012						

*Ford. -10°C kondens.54,4°C - 230 / 50Hz

Kompressoraggregat

Kølekapacitet **368 W***



R404a
Max afstand
8 m

Dim. 430x450x300

D181104410

Indhent pris



Tropeudførelse



Ventileret køling



Elektrisk afrimning



Automatisk genfordampning af tøvand



Isolation 60 mm



Pris i DKK

						Pris i DKK
Uden bordplade	Hylder GN1/1	Hylddevinkler	Vægt	Dimensioner	Ekskl. moms og afgifter	
TS09/3MR	-	-	65	610x680x810	14.733,00	
T141101002						
Med bordplade	Hylder GN1/1	Hylddevinkler	Vægt	Dimensioner	Ekskl. moms og afgifter	
TP09/3MR	-	-	75	610x700x850	15.608,00	
T141111002						
Med bordplade m. bagkant	Hylder GN1/1	Hylddevinkler	Vægt	Dimensioner	Ekskl. moms og afgifter	
TA09/3MR	-	-	80	610x700x950	16.027,00	
T141121002						

*Ford. -10°C kondens.54,4°C - 230 / 50Hz

Kompressoraggregat

Kølekapacitet **368 W***



R404a
Max afstand
8 m

Dim. 430x450x300

D181104410

Indhent pris



Tropeudførelse



Ventileret køling



Elektrisk afrimning



Automatisk genfordampning af tøvand



Isolation 60 mm

Catering

Borde

Master GN1/1 (separat kompressor)

Dybde 700 mm



						Pris i DKK
Uden bordplade	Hylder GN1/1	Hyldevinkler	Vægt	Dimensioner	Ekskl. moms og afgifter	
TS13/1MR	2	2	70	1090x680x810		14.497,00
T142100002						
Med bordplade	Hylder GN1/1	Hyldevinkler	Vægt	Dimensioner	Ekskl. moms og afgifter	
TP13/1MR	2	2	90	1090x700x850		15.496,00
T142110002						
Med bordplade m. bagkant	Hylder GN1/1	Hyldevinkler	Vægt	Dimensioner	Ekskl. moms og afgifter	
TA13/1MR	2	2	95	1090x700x950		15.684,00
T142120002						

*Ford. -10°C kondens.54,4°C - 230 / 50Hz

Kompressoraggregat

Kølekapacitet **565 W***



R404a
Max afstand
8 m

Dim. 430x450x300

D181106110

Indhent pris



Tropeudførelse

+43°

Isolation 60 mm



Ventileret køling



Elektrisk afrimning



Automatisk genfordampning af tøvand



						Pris i DKK
Uden bordplade	Hylder GN1/1	Hyldevinkler	Vægt	Dimensioner	Ekskl. moms og afgifter	
TS13/2MR	1	1	75	1090x680x810		16.124,00
T142100012						
Med bordplade	Hylder GN1/1	Hyldevinkler	Vægt	Dimensioner	Ekskl. moms og afgifter	
TP13/2MR	1	1	95	1090x700x850		17.220,00
T142110012						
Med bordplade m. bagkant	Hylder GN1/1	Hyldevinkler	Vægt	Dimensioner	Ekskl. moms og afgifter	
TA13/2MR	1	1	100	1090x700x950		17.381,00
T142120012						

*Ford. -10°C kondens.54,4°C - 230 / 50Hz

Kompressoraggregat

Kølekapacitet **565 W***



R404a
Max afstand
8 m

Dim. 430x450x300

D181106110

Indhent pris



Tropeudførelse

+43°

Isolation 60 mm



Ventileret køling



Elektrisk afrimning



Automatisk genfordampning af tøvand



						Pris i DKK
Uden bordplade	Hylder GN1/1	Hyldevinkler	Vægt	Dimensioner	Ekskl. moms og afgifter	
TS13/3MR	1	1	75	1090x680x810		16.183,00
T142101002						
Med bordplade	Hylder GN1/1	Hyldevinkler	Vægt	Dimensioner	Ekskl. moms og afgifter	
TP13/3MR	1	1	95	1090x700x850		17.316,00
T142111002						
Med bordplade m. bagkant	Hylder GN1/1	Hyldevinkler	Vægt	Dimensioner	Ekskl. moms og afgifter	
TA13/3MR	1	1	100	1090x700x950		17.504,00
T142121002						

*Ford. -10°C kondens.54,4°C - 230 / 50Hz

Kompressoraggregat

Kølekapacitet **565 W***



R404a
Max afstand
8 m

Dim. 430x450x300

D181106110

Indhent pris



Tropeudførelse

+43°

Isolation 60 mm



Ventileret køling



Elektrisk afrimning



Automatisk genfordampning af tøvand

Catering

Borde

Master GN1/1 (separat kompressor)

Dybde 700 mm



						Pris i DKK
Uden bordplade	Hylder GN1/1	Hyldevinkler	Vægt	Dimensioner	Ekskl. moms og afgifter	
TS13/4MR	-	-	75	1090x680x810	17.725,00	
T14210022						
Med bordplade	Hylder GN1/1	Hyldevinkler	Vægt	Dimensioner	Ekskl. moms og afgifter	
TP13/4MR	-	-	95	1090x700x850	18.847,00	
T142110022						
Med bordplade m. bagkant	Hylder GN1/1	Hyldevinkler	Vægt	Dimensioner	Ekskl. moms og afgifter	
TA13/4MR	-	-	100	1090x700x950	19.008,00	
T142120022						

*Ford. -10°C kondens.54,4°C - 230 / 50Hz

Kompressoraggregat

Kølekapacitet **565 W***



R404a
Max afstand
8 m

Dim. 430x450x300

D181106110

Indhent pris



Tropeduførelse

Isolation 60 mm



Ventileret køling



Elektrisk afrimning



Automatisk genfordampning af tøvand



						Pris i DKK
Uden bordplade	Hylder GN1/1	Hyldevinkler	Vægt	Dimensioner	Ekskl. moms og afgifter	
TS13/5MR	-	-	75	1090x680x810	16.425,00	
T142101012						
Med bordplade	Hylder GN1/1	Hyldevinkler	Vægt	Dimensioner	Ekskl. moms og afgifter	
TP13/5MR	-	-	95	1090x700x850	19.164,00	
T142111012						
Med bordplade m. bagkant	Hylder GN1/1	Hyldevinkler	Vægt	Dimensioner	Ekskl. moms og afgifter	
TA13/5MR	-	-	100	1090x700x950	19.319,00	
T142121012						

*Ford. -10°C kondens.54,4°C - 230 / 50Hz

Kompressoraggregat

Cooling capacity **565 W***



R404a
Max afstand
8 m

Dim. 430x450x300

D181106110

Indhent pris



Tropeduførelse

Isolation 60 mm



Ventileret køling



Elektrisk afrimning



Automatisk genfordampning af tøvand



						Pris i DKK
Uden bordplade	Hylder GN1/1	Hyldevinkler	Vægt	Dimensioner	Ekskl. moms og afgifter	
TS13/6MR	-	-	75	1090x680x810	19.164,00	
T142100112						
Med bordplade	Hylder GN1/1	Hyldevinkler	Vægt	Dimensioner	Ekskl. moms og afgifter	
TP13/6MR	-	-	95	1090x700x850	20.141,00	
T142110112						
Med bordplade m. bagkant	Hylder GN1/1	Hyldevinkler	Vægt	Dimensioner	Ekskl. moms og afgifter	
TA13/6MR	-	-	100	1090x700x950	19.765,00	
T142120112						

*Ford. -10°C kondens.54,4°C - 230 / 50Hz

Kompressoraggregat

Kølekapacitet **565 W***



R404a
Max afstand
8 m

Dim. 430x450x300

D181106110

Indhent pris



Tropeduførelse

Isolation 60 mm



Ventileret køling



Elektrisk afrimning



Automatisk genfordampning af tøvand

Catering

Borde

Master GN1/1 (separat kompressor)

Dybde 700 mm



						Pris i DKK
Uden bordplade	Hylder GN1/1	Hyldevinkler	Vægt	Dimensioner	Ekskl. moms og afgifter	
TS17/1MR	3	3	100	1570x680x810		17.441,00
T143100002						
Med bordplade	Hylder GN1/1	Hyldevinkler	Vægt	Dimensioner	Ekskl. moms og afgifter	
TP17/1MR	3	3	125	1570x700x850		18.729,00
T143110002						
Med bordplade m. bagkant	Hylder GN1/1	Hyldevinkler	Vægt	Dimensioner	Ekskl. moms og afgifter	
TA17/1MR	3	3	130	1570x700x950		18.891,00
T143120002						

*Ford. -10°C kondens.54,4°C - 230 / 50Hz

Kompressoraggregat

Kølekapacitet **565 W***



R404a
Max afstand
8 m

Dim. 430x450x300

D181108910

Indhent pris



Tropeudførelse



60 Isolation 60 mm



Ventileret køling



Elektrisk afrimning



Automatisk genfordampning af tøvand

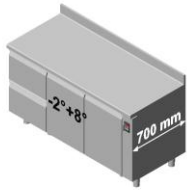

						Pris i DKK
Uden bordplade	Hylder GN1/1	Hyldevinkler	Vægt	Dimensioner	Ekskl. moms og afgifter	
TS17/2MR	2	2	105	1570x680x810		19.138,00
T143100012						
Med bordplade	Hylder GN1/1	Hyldevinkler	Vægt	Dimensioner	Ekskl. moms og afgifter	
TP17/2MR	2	2	130	1570x700x850		20.453,00
T143110012						
Med bordplade m. bagkant	Hylder GN1/1	Hyldevinkler	Vægt	Dimensioner	Ekskl. moms og afgifter	
TA17/2MR	2	2	135	1570x700x950		20.614,00
T143120012						

*Ford. -10°C kondens.54,4°C - 230 / 50Hz

Kompressoraggregat

Kølekapacitet **565 W***



R404a
Max afstand
8 m

Dim. 430x450x300

D181108910

Indhent pris



Tropeudførelse



60 Isolation 60 mm



Ventileret køling



Elektrisk afrimning



Automatisk genfordampning af tøvand

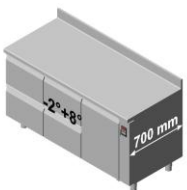

						Pris i DKK
Uden bordplade	Hylder GN1/1	Hyldevinkler	Vægt	Dimensioner	Ekskl. moms og afgifter	
TS17/3MR	1	1	105	1570x680x810		20.738,00
T143100022						
Med bordplade	Hylder GN1/1	Hyldevinkler	Vægt	Dimensioner	Ekskl. moms og afgifter	
TP17/3MR	1	1	130	1570x700x850		22.027,00
T143110022						
Med bordplade m. bagkant	Hylder GN1/1	Hyldevinkler	Vægt	Dimensioner	Ekskl. moms og afgifter	
TA17/3MR	1	1	135	1570x700x950		22.183,00
T143120022						

*Ford. -10°C kondens.54,4°C - 230 / 50Hz

Kompressoraggregat

Kølekapacitet **565 W***



R404a
Max afstand
8 m

Dim. 430x450x300

D181108910

Indhent pris



Tropeudførelse



60 Isolation 60 mm



Ventileret køling



Elektrisk afrimning



Automatisk genfordampning af tøvand

Catering

Borde

Master GN1/1 (separat kompressor)

Dybde 700 mm

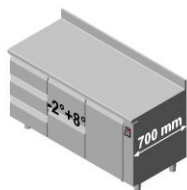

						Pris i DKK
Uden bordplade	Hylder GN1/1	Hylddevinkler	Vægt	Dimensioner	Ekskl. moms og afgifter	
TS17/4MR	1	1	105	1570x680x810		21.651,00
T143100112						
Med bordplade	Hylder GN1/1	Hylddevinkler	Vægt	Dimensioner	Ekskl. moms og afgifter	
TP17/4MR	1	1	130	1570x700x850		22.934,00
T143110112						
Med bordplade m. bagkant	Hylder GN1/1	Hylddevinkler	Vægt	Dimensioner	Ekskl. moms og afgifter	
TA17/4MR	1	1	135	1570x700x950		23.095,00
T143120112						

*Ford. -10°C kondens.54,4°C - 230 / 50Hz

Kompressoraggregat

Kølekapacitet **565 W***



R404a
Max afstand
8 m

Dim. 430x450x300

D181108910

Indhent pris



Trapeudførelse



Isolation 60 mm



Ventileret køling



Elektrisk afrimning



Automatisk genfordampning af tøvand

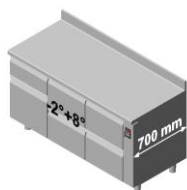

						Pris i DKK
Uden bordplade	Hylder GN1/1	Hylddevinkler	Vægt	Dimensioner	Ekskl. moms og afgifter	
TS17/5MR	-	-	110	1570x680x810		22.650,00
T143101022						
Med bordplade	Hylder GN1/1	Hylddevinkler	Vægt	Dimensioner	Ekskl. moms og afgifter	
TP17/5MR	-	-	135	1570x700x850		23.939,00
T143111022						
Med bordplade m. bagkant	Hylder GN1/1	Hylddevinkler	Vægt	Dimensioner	Ekskl. moms og afgifter	
TA17/5MR	-	-	140	1570x700x950		24.094,00
T143121022						

*Ford. -10°C kondens.54,4°C - 230 / 50Hz

Kompressoraggregat

Kølekapacitet **565 W***



R404a
Max distance
8 m

Dim. 430x450x300

D181108910

Indhent pris



Trapeudførelse



Isolation 60 mm



Ventileret køling



Elektrisk afrimning



Automatisk genfordampning af tøvand

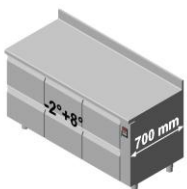

						Pris i DKK
Uden bordplade	Hylder GN1/1	Hylddevinkler	Vægt	Dimensioner	Ekskl. moms og afgifter	
TS17/6MR	-	-	115	1570x680x810		22.526,00
T143100032						
Med bordplade	Hylder GN1/1	Hylddevinkler	Vægt	Dimensioner	Ekskl. moms og afgifter	
TP17/6MR	-	-	140	1570x700x850		23.810,00
T143110032						
Med bordplade m. bagkant	Hylder GN1/1	Hylddevinkler	Vægt	Dimensioner	Ekskl. moms og afgifter	
TA17/6MR	-	-	145	1570x700x950		23.428,00
T143120032						

*Ford. -10°C kondens.54,4°C - 230 / 50Hz

Kompressoraggregat

Kølekapacitet **565 W***



R404a
Max afstand
8 m

Dim. 430x450x300

D181108910

Indhent pris



Trapeudførelse



Isolation 60 mm



Ventileret køling



Elektrisk afrimning



Automatisk genfordampning af tøvand

Catering

Borde

Master GN1/1 (separat kompressor)

Dybde 700 mm

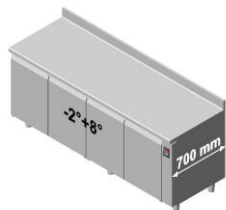

						Pris i DKK
Uden bordplade	Hylder GN1/1	Hylddevinkler	Vægt	Dimensioner	Ekskl. moms og afgifter	
TS21/1MR	4	4	130	2050x680x810		20.213,00
T144100002						
Med bordplade	Hylder GN1/1	Hylddevinkler	Vægt	Dimensioner	Ekskl. moms og afgifter	
TP21/1MR	4	4	155	2050x700x850		21.685,00
T144110002						
Med bordplade m. bagkant	Hylder GN1/1	Hylddevinkler	Vægt	Dimensioner	Ekskl. moms og afgifter	
TA21/1MR	4	4	160	2050x700x950		21.841,00
T144120002						

*Ford. -10°C kondens.54,4°C - 230 / 50Hz

Kompressoraggregat

Kølekapacitet **565 W***



R404a
Max afstand
8 m

Dim. 430x450x300

D181108910

Indhent pris



Tropeudførelse



60 Isolation 60 mm



Ventileret køling



Elektrisk afrimning



Automatisk genfordampning af tøvand

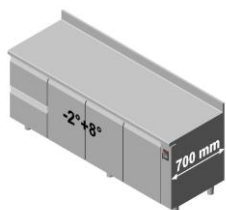

						Pris i DKK
Uden bordplade	Hylder GN1/1	Hylddevinkler	Vægt	Dimensioner	Ekskl. moms og afgifter	
TS21/2MR	3	3	135	2050x680x810		21.969,00
T144100012						
Med bordplade	Hylder GN1/1	Hylddevinkler	Vægt	Dimensioner	Ekskl. moms og afgifter	
TP21/2MR	3	3	160	2050x700x850		23.414,00
T144110012						
Med bordplade m. bagkant	Hylder GN1/1	Hylddevinkler	Vægt	Dimensioner	Ekskl. moms og afgifter	
TA21/2MR	3	3	165	2050x700x950		23.597,00
T144120012						

*Ford. -10°C kondens.54,4°C - 230 / 50Hz

Kompressoraggregat

Kølekapacitet **565 W***



R404a
Max afstand
8 m

Dim. 430x450x300

D181108910

Indhent pris



Tropeudførelse



60 Isolation 60 mm



Ventileret køling



Elektrisk afrimning



Automatisk genfordampning af tøvand

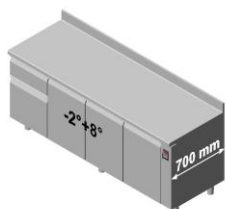

						Pris i DKK
Uden bordplade	Hylder GN1/1	Hylddevinkler	Vægt	Dimensioner	Ekskl. moms og afgifter	
TS21/3MR	3	3	135	2050x680x810		20.417,00
T144101002						
Med bordplade	Hylder GN1/1	Hylddevinkler	Vægt	Dimensioner	Ekskl. moms og afgifter	
TP21/3MR	3	3	160	2050x700x850		23.511,00
T144111002						
Med bordplade m. bagkant	Hylder GN1/1	Hylddevinkler	Vægt	Dimensioner	Ekskl. moms og afgifter	
TA21/3MR	3	3	165	2050x700x950		23.666,00
T144121002						

*Ford. -10°C kondens.54,4°C - 230 / 50Hz

Kompressoraggregat

Kølekapacitet **565 W***



R404a
Max afstand
8 m

Dim. 430x450x300

D181108910

Indhent pris



Tropeudførelse



60 Isolation 60 mm



Ventileret køling



Elektrisk afrimning



Automatisk genfordampning af tøvand

Catering

Borde

Master GN1/1 (separat kompressor)

Dybde 700 mm

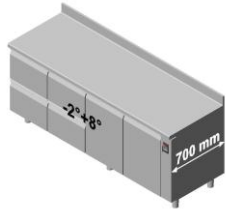

						Pris i DKK
Uden bordplade	Hylder GN1/1	Hyldvinkler	Vægt	Dimensioner	Ekskl. moms og afgifter	
TS21/4MR	2	2	140	2050x680x810		23.597,00
T144100022						
Med bordplade	Hylder GN1/1	Hyldvinkler	Vægt	Dimensioner	Ekskl. moms og afgifter	
TP21/4MR	2	2	165	2050x700x850		23.967,00
T144110022						
Med bordplade m. bagkant	Hylder GN1/1	Hyldvinkler	Vægt	Dimensioner	Ekskl. moms og afgifter	
TA21/4MR	2	2	170	2050x700x950		25.197,00
T144120022						

*Ford. -10°C kondens.54,4°C - 230 / 50Hz

Kompressoraggregat

Kølekapacitet **565 W***



R404a
Max afstand
8 m

Dim. 430x450x300

D181108910

Indhent pris



Trapeudførelse



60 Isolation 60 mm



Ventileret køling



Elektrisk afrimning



Automatisk genfordampning af tøvand

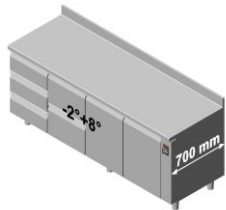

						Pris i DKK
Uden bordplade	Hylder GN1/1	Hyldvinkler	Vægt	Dimensioner	Ekskl. moms og afgifter	
TS21/5MR	2	2	140	2050x680x810		24.569,00
T144100112						
Med bordplade	Hylder GN1/1	Hyldvinkler	Vægt	Dimensioner	Ekskl. moms og afgifter	
TP21/5MR	2	2	165	2050x700x850		26.013,00
T144110112						
Med bordplade m. bagkant	Hylder GN1/1	Hyldvinkler	Vægt	Dimensioner	Ekskl. moms og afgifter	
TA21/5MR	2	2	170	2050x700x950		26.174,00
T144120112						

*Ford. -10°C kondens.54,4°C - 230 / 50Hz

Kompressoraggregat

Kølekapacitet **565 W***



R404a
Max afstand
8 m

Dim. 430x450x300

D181108910

Indhent pris



Trapeudførelse



60 Isolation 60 mm



Ventileret køling



Elektrisk afrimning



Automatisk genfordampning af tøvand

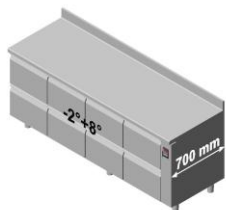

						Pris i DKK
Uden bordplade	Hylder GN1/1	Hyldvinkler	Vægt	Dimensioner	Ekskl. moms og afgifter	
TS21/6MR	-	-	160	2050x680x810		27.146,00
T144100042						
Med bordplade	Hylder GN1/1	Hyldvinkler	Vægt	Dimensioner	Ekskl. moms og afgifter	
TP21/6MR	-	-	185	2050x700x850		28.618,00
T144110042						
Med bordplade m. bagkant	Hylder GN1/1	Hyldvinkler	Vægt	Dimensioner	Ekskl. moms og afgifter	
TA21/6MR	-	-	190	2050x700x950		28.774,00
T144120042						

*Ford. -10°C kondens.54,4°C - 230 / 50Hz

Kompressoraggregat

Kølekapacitet **565 W***



R404a
Max afstand
8 m

Dim. 430x450x300

D181108910

Indhent pris



Trapeudførelse



60 Isolation 60 mm



Ventileret køling



Elektrisk afrimning



Automatisk genfordampning af tøvand

Catering

Borde

Master GN1/1 frys (separat kompressor)

Dybde 700 mm



						Pris i DKK
Uden bordplade TS09/1BR T141100004	Hylder GN1/1 1	Hylddevinkler 1	Vægt 60	Dimensioner 610x680x810	Ekskl. moms og afgifter 14.921,00	
Med bordplade TP09/1BR T141110004	Hylder GN1/1 1	Hylddevinkler 1	Vægt 70	Dimensioner 610x700x810	Ekskl. moms og afgifter 15.834,00	
Med bordplade m. bagkant TA09/1BR T141120004	Hylder GN1/1 1	Hylddevinkler 1	Vægt 75	Dimensioner 610x700x810	Ekskl. moms og afgifter 15.920,00	

*Ford. -23,3°C kondens.54,4°C - 230 / 50Hz



R404a
Max afstand
8 m

464 W*
D182117410
Indhent pris



Tropeudførelse



Ventileret køling



Elektrisk afrimning



Automatisk genfordampning af tøvand

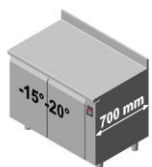

						Pris i DKK
Uden bordplade TS13/1BR T142100004	Hylder GN1/1 2	Hylddevinkler 2	Vægt 70	Dimensioner 1090x680x810	Ekskl. moms og afgifter 17.161,00	
Med bordplade TP13/1BR T142110004	Hylder GN1/1 2	Hylddevinkler 2	Vægt 95	Dimensioner 1090x700x850	Ekskl. moms og afgifter 18.160,00	
Med bordplade m. bagkant TA13/1BR T142120004	Hylder GN1/1 2	Hylddevinkler 2	Vægt 100	Dimensioner 1090x700x950	Ekskl. moms og afgifter 18.294,00	

*Ford. -23,3°C kondens.54,4°C - 230 / 50Hz



R404a
Max afstand
8 m

616 W*
D182117410
Indhent pris



Tropeudførelse



Ventileret køling



Elektrisk afrimning



Automatisk genfordampning af tøvand

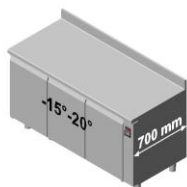

						Pris i DKK
Uden bordplade TS17/1BR T143100004	Hylder GN1/1 3	Hylddevinkler 3	Vægt 100	Dimensioner 1570x680x810	Ekskl. moms og afgifter 19.863,00	
Med bordplade TP17/1BR T143110004	Hylder GN1/1 3	Hylddevinkler 3	Vægt 125	Dimensioner 1570x700x850	Ekskl. moms og afgifter 21.184,00	
Med bordplade m. bagkant TA17/1BR T143120004	Hylder GN1/1 3	Hylddevinkler 3	Vægt 130	Dimensioner 1570x700x950	Ekskl. moms og afgifter 21.334,00	

*Ford. -23,3°C kondens.54,4°C - 230 / 50Hz



R404a
Max afstand
8 m

782 W*
D182117410
Indhent pris



Tropeudførelse



Ventileret køling



Elektrisk afrimning



Automatisk genfordampning af tøvand

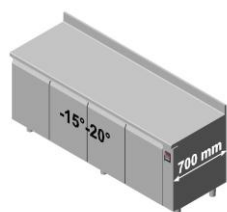

						Pris i DKK
Uden bordplade TS21/1BR T144100004	Hylder GN1/1 4	Hylddevinkler 4	Vægt 130	Dimensioner 2050x680x810	Ekskl. moms og afgifter 22.410,00	
Med bordplade TP21/1BR T144110004	Hylder GN1/1 4	Hylddevinkler 4	Vægt 155	Dimensioner 2050x700x850	Ekskl. moms og afgifter 23.978,00	
Med bordplade m. bagkant TA21/1BR T144120004	Hylder GN1/1 4	Hylddevinkler 4	Vægt 160	Dimensioner 2050x700x950	Ekskl. moms og afgifter 24.134,00	

*Ford. -23,3°C kondens.54,4°C - 230 / 50Hz



R404a
Max afstand
8 m

935 W*
D182120410
Indhent pris



Tropeudførelse



Ventileret køling



Elektrisk afrimning



Automatisk genfordampning af tøvand

Catering

Borde

Skuffer til køle- og fryseborde Master GN1/1

Dybde 700 mm

>Produkt	>>Type	>>>Varenummer		>>>Pris
Borde Master GN1/1	H710	D623012020	2/2 skuffesæt (monteret på fabrikken) – H710 mm	Pris i DKK (ekskl. moms) 2.041,00
	H660	D623012060	2/2 skuffesæt (monteret på fabrikken) – H660 mm	

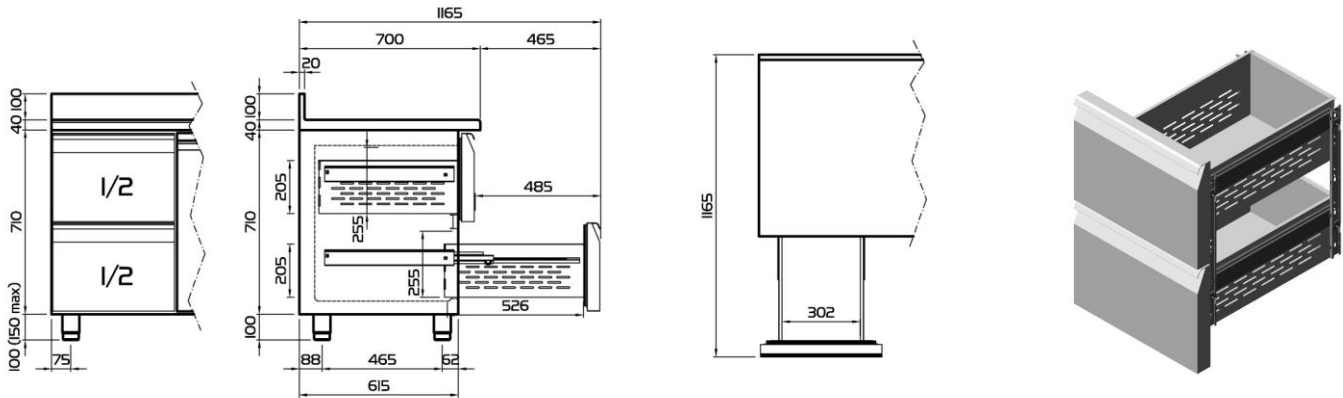

>Produkt	>>Type	>>>Varenummer		>>>Pris
Borde Master GN1/1	H710	D623013020	3/3 skuffesæt (monteret på fabrikken) – H710 mm	Pris i DKK (ekskl. moms) 3.174,00
	H660	D623013060	3/3 skuffesæt (monteret på fabrikken) – H660 mm	

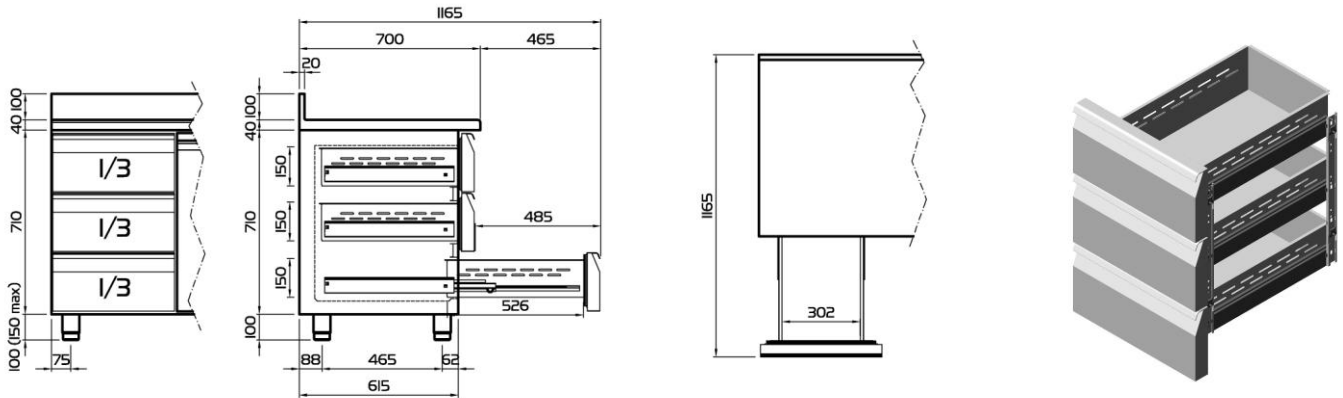

*Øverste 1/3 skuffe (3 og 4 dørs) H 100 mm

>Produkt	>>Type	>>>Varenummer		>>>Pris
Borde Master GN1/1	H710	D623023020	1/3+2/3 skuffer (monteret på fabrikken), H710 mm	Pris i DKK (ekskl. moms) 2.324,00
	H660	D623023060	1/3+2/3 skuffer (monteret på fabrikken), H660 mm	

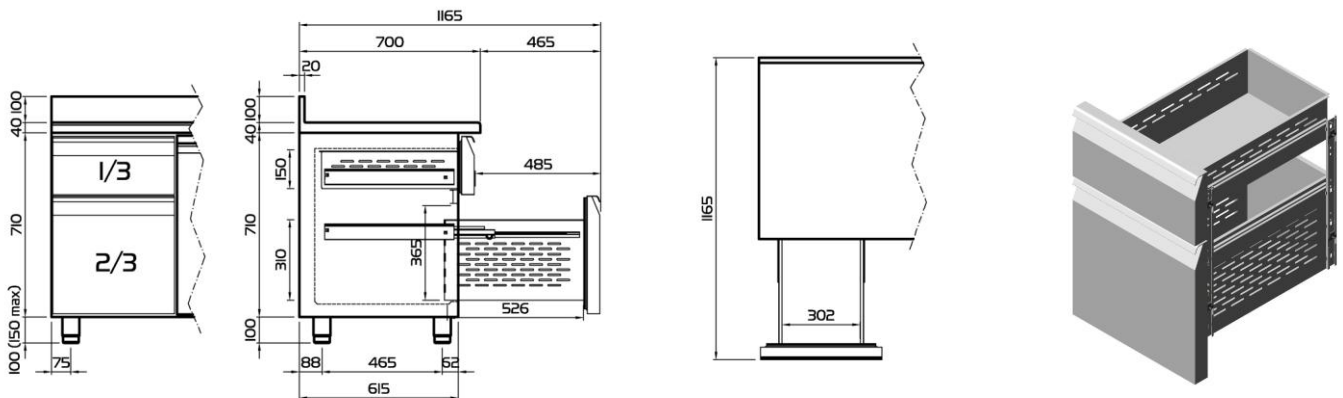

*Øverste 1/3 skuffe (3 og 4 dørs) H 100 mm

>Product	>>Type	>>>Code	>>>Code
Borde Master GN1/1	1 dørs	O221325530	O121150520
	2 dørs	Plastik coated trådhyldte GN1/1	Rustfri hyldebærere U profile, sæt af 2 stk. Type C – 505 mm
	3 dørs		
	4 dørs		
		Pris i DKK (ekskl. moms)	Pris i DKK (ekskl. moms)
		Bestilt med bord: 179,00	Bestilt med bord: 164,00
		I løs vægt 219,00	I løs vægt 204,00
		Ab lager	Ab lager
	>>Type	>>>Code	>>>Code
	1 dørs	O444000020	O446000020
	2 dørs	Rustfrit hjulsæt (4 hjul sving- og låsbare) for 1/2 dørs modeller	Rustfrit hjulsæt (6 hjul sving- og låsbare) for 3/4 dørs modeller
	3 dørs		
	4 dørs		
		Pris i DKK (ekskl. moms)	Pris i DKK (ekskl. moms)
		1.641,00	2.461,00

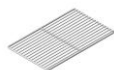

>Product	>>Type	>>>Code
Borde Master GN1/1	2/3/4 dørs med indbygget kompressor	Og22100020 Vask Ø 300 mm
		Pris i DKK (ekskl. moms)
		4.326,00
		>>>Code
		Og22200020
		Blandingsbatteri Ø 3/4
		Pris i DKK (ekskl. moms)
		2.536,00

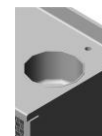
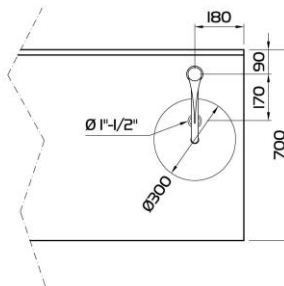
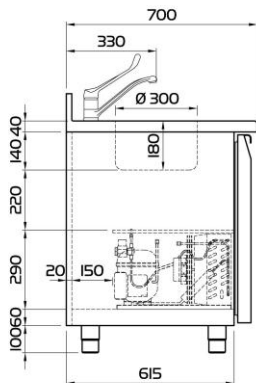
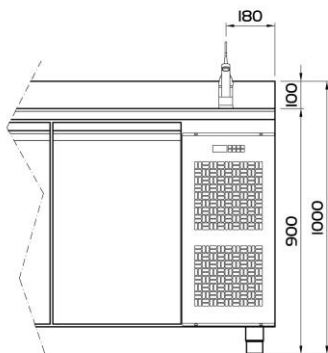

*Afløbshul er ikke inklusiv

EGENSKABER

Udvendig/indvendig i rustfrit AISI 304 stål

Isolationstykkelse 60 mm

Afrundede hjørner

Højdejusterbare ben i rustfrit stål

Selvlukkende vendbare døre, der kan åbnes 105°

Greb i rustfrit stål

Magnet tætningslister – nemme at rengøre og udskifte

Hyldevanger og hyldevinkler i rustfrit stål

Korrosionsbestandige rilsan hylde GN1/1

Bordplade i forskellige udførelser (option)

Støjdæmpet kompressorum

Konstruerede for drift ved omgivelsestemperaturer på op til +43° C

Kompressorum placeret til højre (kan uden merpris placeres til venstre efter ønske)

Ventileret kulde

Coated fordampere (cataphoresis) for at modvirke tæring

Fuldt udskifteligt kølesystem

Hot gas afrimning (for modeller med indbygget kompressor), elektrisk afrimning (for modeller for separat kompressor)

Genfordampning af tøvand

Elektronisk styring

Dybde 700 mm
SKRÆDDERSYET BRØND EFTER ØNSKE



1 dørs (indbygget kompressor)

2 dørs (indbygget kompressor)

3 dørs (indbygget kompressor)

4 dørs (indbygget kompressor)



Side 81



Side 81



Side 81



Side 81

1 dørs (for separat kompressor)

2 dørs (for separat kompressor)

3 dørs (for separat kompressor)

4 dørs (for separat kompressor)



Side 82



Side 82



Side 82



Side 82



Dybde 700 mm – Højde 710 mm (Højde 660 mm efter ønske)

1 dørs

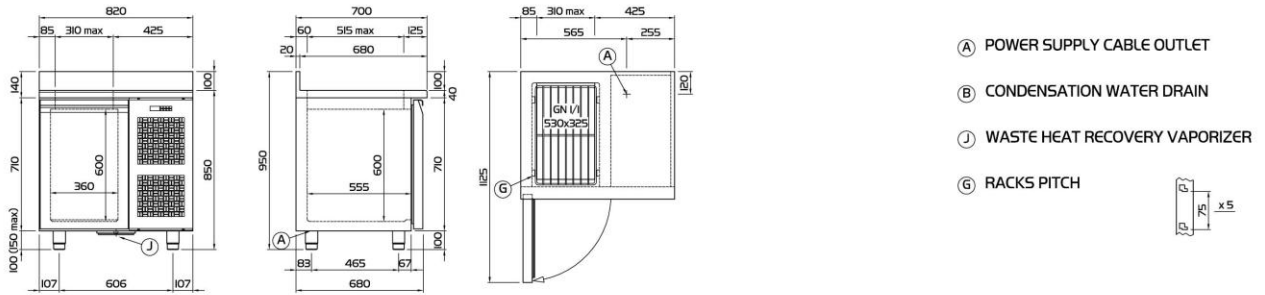

2 dørs

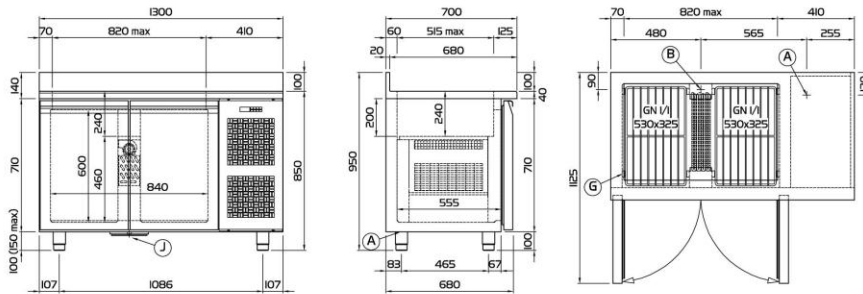

3 dørs

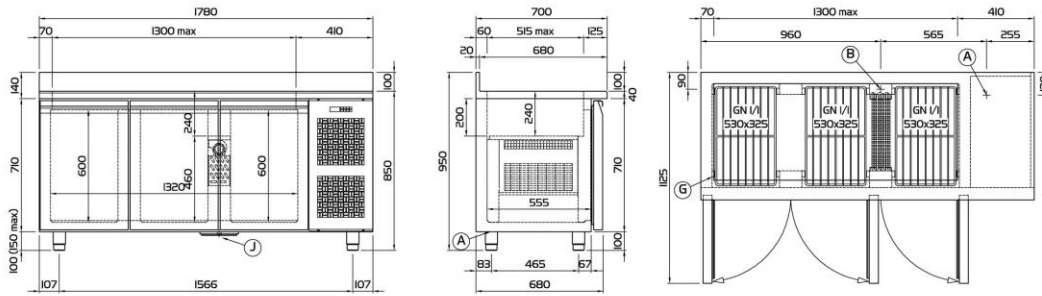

4 dørs

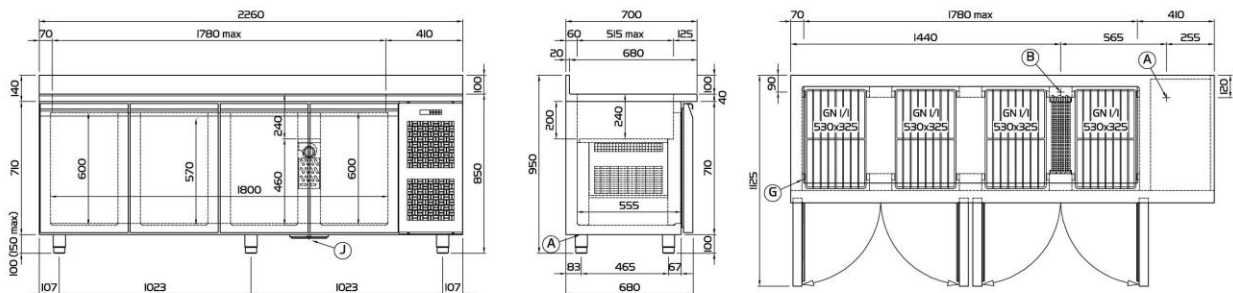

Dybde 700 mm – Højde 710 mm (Højde 660 mm efter ønske)

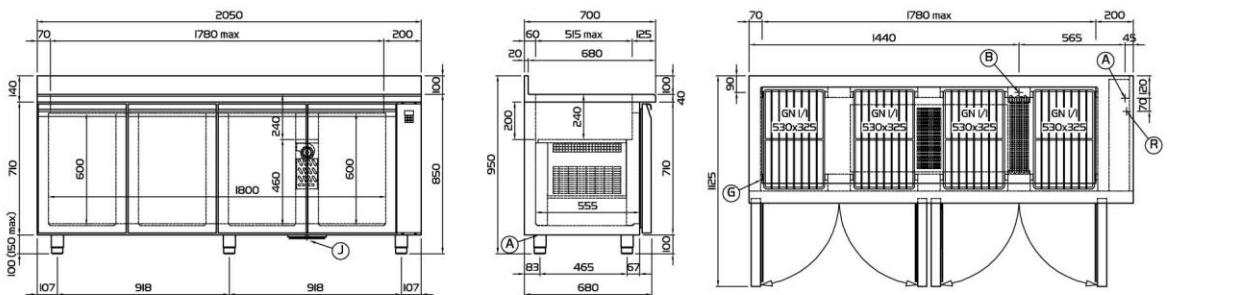
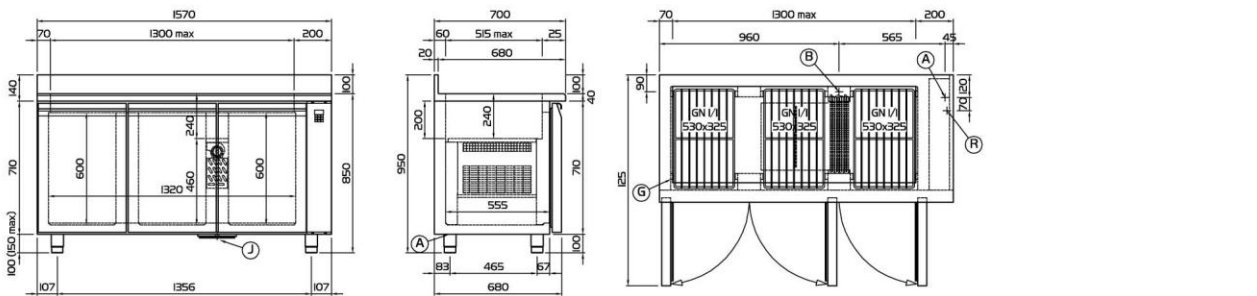
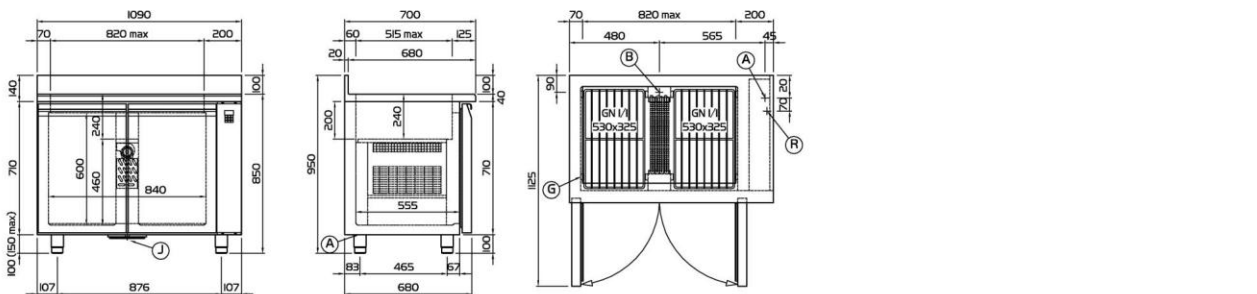
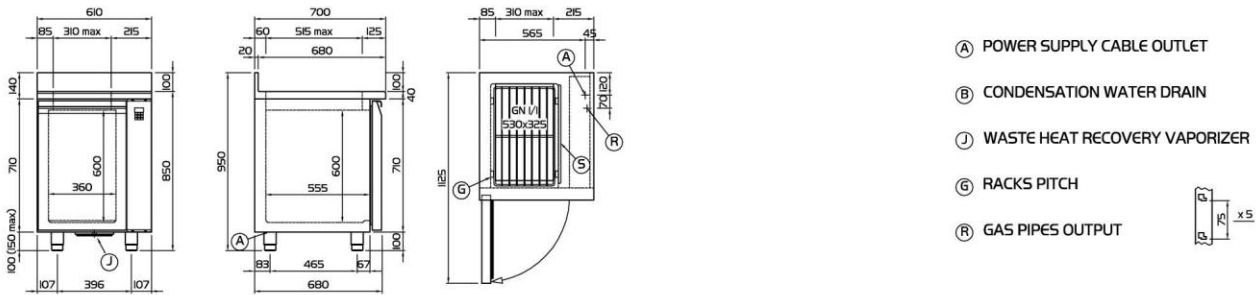

1 dørs

2 dørs

3 dørs

4 dørs

Catering

Saladetter

*Prisen er med udskæring i bordpladen, men uden brønd.
Se pris for brønd side 83



Uden bordplade	Hylde GN1/1	Hyldevinkler	Vægt	Dimensioner	Ekskl. moms og afgifter
TS09/1MD	1	1	60	820x680x810	16.543,00*
T181000002					
Med bordplade	Hylde GN1/1	Hyldevinkler	Vægt	Dimensioner	Ekskl. moms og afgifter
TP09/1MD	1	1	80	820x700x810	17.456,00*
T181010002					
Med bordplade m. bagkant	Hylde GN1/1	Hyldevinkler	Vægt	Dimensioner	Ekskl. moms og afgifter
TA09/1MD	1	1	85	820x700x810	17.542,00*
T181020002					

*Ford. -10°C kondens.54,4°C - 230 / 50Hz

Optagen effekt	344 W - 1,9 A
Kølekapacitet	368 W*
Kølemiddel	R404a

60

+43°

Tropeudførelse



Ventileret køling

GAS

Hot gas afrimning



Automatisk genfordampning af tøvand

*Prisen er med udskæring i bordpladen, men uden brønd.
Se pris for brønd side 83



Uden bordplade	Hylde GN1/1	Hyldevinkler	Vægt	Dimensioner	Ekskl. moms og afgifter
TS13/1MD	2	2	80	1300x680x810	18.680,00*
T182000002					
Med bordplade	Hylde GN1/1	Hyldevinkler	Vægt	Dimensioner	Ekskl. moms og afgifter
TP13/1MD	2	2	100	1300x700x850	19.808,00*
T182010002					
Med bordplade m. bagkant	Hylde GN1/1	Hyldevinkler	Vægt	Dimensioner	Ekskl. moms og afgifter
TA13/1MD	2	2	105	1300x700x950	19.959,00*
T182020002					

*Ford. -10°C kondens.54,4°C - 230 / 50Hz

Optagen effekt	546 W - 3,1 A
Kølekapacitet	565 W*
Kølemiddel	R404a

60

+43°

Tropeudførelse



Ventileret køling

GAS

Hot gas afrimning



Automatisk genfordampning af tøvand

*Prisen er med udskæring i bordpladen, men uden brønd.
Se pris for brønd side 83



Uden bordplade	Hylde GN1/1	Hyldevinkler	Vægt	Dimensioner	Ekskl. moms og afgifter
TS17/1MD	3	3	110	1780x680x810	21.769,00*
T183000002					
Med bordplade	Hylde GN1/1	Hyldevinkler	Vægt	Dimensioner	Ekskl. moms og afgifter
TP17/1MD	3	3	135	1780x700x850	23.375,00*
T183010002					
Med bordplade m. bagkant	Hylde GN1/1	Hyldevinkler	Vægt	Dimensioner	Ekskl. moms og afgifter
TA17/1MD	3	3	140	1780x700x950	23.493,00*
T183020002					

*Ford. -10°C kondens.54,4°C - 230 / 50Hz

Optagen effekt	546 W - 3,1 A
Kølekapacitet	565 W*
Kølemiddel	R404a

60

+43°

Tropeudførelse



Ventileret køling

GAS

Hot gas afrimning



Automatisk genfordampning af tøvand

*Prisen er med udskæring i bordpladen, men uden brønd.
Se pris for brønd side 83



Uden bordplade	Hylde GN1/1	Hyldevinkler	Vægt	Dimensioner	Ekskl. moms og afgifter
TS21/1MD	4	4	140	2260x680x810	24.929,00*
T184000002					
Med bordplade	Hylde GN1/1	Hyldevinkler	Vægt	Dimensioner	Ekskl. moms og afgifter
TP21/1MD	4	4	165	2260x700x850	26.626,00*
T184010002					
Med bordplade m. bagkant	Hylde GN1/1	Hyldevinkler	Vægt	Dimensioner	Ekskl. moms og afgifter
TA21/1MD	4	4	170	2260x700x950	26.840,00*
T184020002					

*Ford. -10°C kondens.54,4°C - 230 / 50Hz

Optagen effekt	546 W - 3,1 A
Kølekapacitet	565 W*
Kølemiddel	R404a

60

+43°

Tropeudførelse



Ventileret køling

GAS

Hot gas afrimning



Automatisk genfordampning af tøvand

Catering

Saladetter

*Prisen er med udskæring i bordpladen, men uden brønd.
Se pris for brønd side 83

Saladetter GN1/1

Dybde 700 mm

Pris i DKK



Uden bordplade	Hylde GN1/1	Hyldevinkler	Vægt	Dimensioner	Ekskl. moms og afgifter
TS09/1MDR T181100002	1	1	50	610x680x810	14.491,00*
Med bordplade	Hylde GN1/1	Hyldevinkler	Vægt	Dimensioner	Ekskl. moms og afgifter
TP09/1MDR T181110002	1	1	60	610x700x810	15.404,00*
Med bordplade m. bagkant	Hylde GN1/1	Hyldevinkler	Vægt	Dimensioner	Ekskl. moms og afgifter
TA09/1MDR T181120002	1	1	65	610x700x810	15.490,00*

*Ford. -10°C kondens.54,4°C - 230 / 50Hz



R404a
Max afstand
8 m

565 W*
D181104410
Indhent pris



Tropeudførelse



Ventileret køling



Elektrisk afrimning



Automatisk genfordampning af tøvand

*Prisen er med udskæring i bordpladen, men uden brønd.
Se pris for brønd side 83

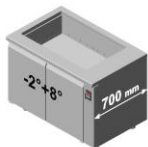

Uden bordplade	Hylde GN1/1	Hyldevinkler	Vægt	Dimensioner	Ekskl. moms og afgifter
TS13/1MDR T182100002	2	2	60	1090x680x810	16.108,00*
Med bordplade	Hylde GN1/1	Hyldevinkler	Vægt	Dimensioner	Ekskl. moms og afgifter
TP13/1MDR T182110002	2	2	85	1090x700x850	17.107,00*
Med bordplade m. bagkant	Hylde GN1/1	Hyldevinkler	Vægt	Dimensioner	Ekskl. moms og afgifter
TA13/1MDR T182120002	2	2	90	1090x700x950	17.295,00*

*Ford. -10°C kondens.54,4°C - 230 / 50Hz



R404a
Max afstand
8 m

565 W*
D181106110
Indhent pris



Tropeudførelse



Ventileret køling



Elektrisk afrimning



Automatisk genfordampning af tøvand

*Prisen er med udskæring i bordpladen, men uden brønd.
Se pris for brønd side 83

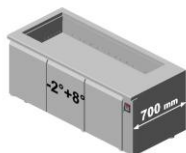

Uden bordplade	Hylde GN1/1	Hyldevinkler	Vægt	Dimensioner	Ekskl. moms og afgifter
TS17/1MDR T183100002	3	3	90	1570x680x810	19.320,00*
Med bordplade	Hylde GN1/1	Hyldevinkler	Vægt	Dimensioner	Ekskl. moms og afgifter
TP17/1MDR T183110002	3	3	115	1570x700x850	20.609,00*
Med bordplade m. bagkant	Hylde GN1/1	Hyldevinkler	Vægt	Dimensioner	Ekskl. moms og afgifter
TA17/1MDR T183120002	3	3	120	1570x700x950	20.770,00*

*Ford. -10°C kondens.54,4°C - 230 / 50Hz



R404a
Max afstand
8 m

565 W*
D181108910
Indhent pris



Tropeudførelse



Ventileret køling



Elektrisk afrimning



Automatisk genfordampning af tøvand

*Prisen er med udskæring i bordpladen, men uden brønd.
Se pris for brønd side 83



Uden bordplade	Hylde GN1/1	Hyldevinkler	Vægt	Dimensioner	Ekskl. moms og afgifter
TS21/1MDR T184100002	4	4	120	2050x680x810	22.362,00*
Med bordplade	Hylde GN1/1	Hyldevinkler	Vægt	Dimensioner	Ekskl. moms og afgifter
TP21/1MDR T184110002	4	4	145	2050x700x850	22.759,00*
Med bordplade m. bagkant	Hylde GN1/1	Hyldevinkler	Vægt	Dimensioner	Ekskl. moms og afgifter
TA21/1MDR T184120002	4	4	150	2050x700x950	22.915,00*

*Ford. -10°C kondens.54,4°C - 230 / 50Hz



R404a
Max afstand
8 m

565 W*
D181108910
Indhent pris



Tropeudførelse











Ventileret køling

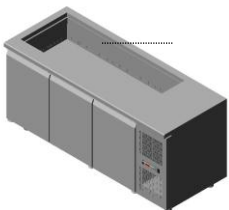

Elektrisk afrimning

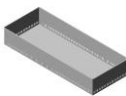
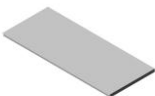
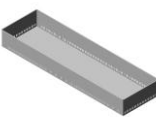

Automatisk genfordampning af tøvand

>Produkt	>>Type	>>>Varenummer	>>>Varenummer
	1 dør	L325821060 Brønd for 1 dørs model Kan skræddersyes på mål	O343101060 Låg for 1 dørs model
		 Pris i DKK (ekskl. moms) 1.507,00	 Pris i DKK (ekskl. moms) 2.014,00
	>>Type	>>>Varenummer	>>>Varenummer
	2 dørs	L325822060 Brønd for 2 dørs model Kan skræddersyes på mål	O343102060 Låg for 2 dørs model
		 Pris i DKK (ekskl. moms) 2.238,00	 Pris i DKK (ekskl. moms) 2.834,00
>>Type	>>>Varenummer	>>>Varenummer	
3 dørs	L325823060 Brønd for 3 dørs model Kan skræddersyes på mål	O343103060 Låg for 3 dørs model	
	 Pris i DKK (ekskl. moms) 3.282,00	 Pris i DKK (ekskl. moms) 3.431,00	
>>Type	>>>Varenummer	>>>Varenummer	
4 dørs	L325824060 Brønd for 4 dørs model Kan skræddersyes på mål	O343104060 Låg for 4 dørs model	
	 Pris i DKK (ekskl. moms) 4.326,00	 Pris i DKK (ekskl. moms) 3.953,00	
>>Type	>>>Varenummer	>>>Varenummer	
1 dørs 2 dørs 3 dørs 4 dørs	O221325530 Plastik coated trådhylde GN1/1	O121150520 Rustfri hyldebærere U profile, sæt af 2 stk. Type C – 505 mm	
	 Pris i DKK (ekskl. moms) Bestilt med bord: 179,00 I løs vægt 219,00 Ab lager	 Pris i DKK (ekskl. moms) Bestilt med bord: 164,00 I løs vægt 204,00 Ab lager	

Eksempler på kantinekombinationer i brønd (NB ! Brønd leveres uden kintiner)

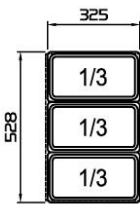
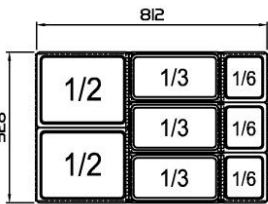
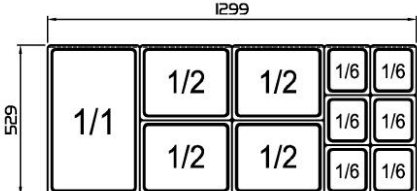
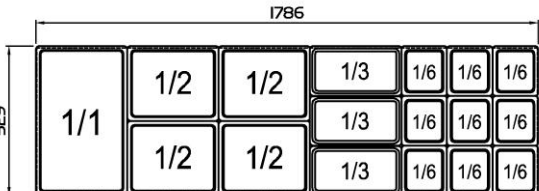
>>>Code	>>>Code
1 dørs	2 dørs
	
3 dørs	4 dørs
	

EGENSKABER

Udvendig/indvendig i rustfrit AISI 304 stål
 Isolationstykkelse 50 mm på modellen for 3 stk. 2/3 GN-bakker
 Isolationstykkelse 60 mm på modeller for 5-14 stk. 1/1 GN-bakker
 Isolationstykkelse 75 mm på modeller for 20 stk. 1/1 GN-bakker samt indkøringsmodellen for 20 stk. 1/1 GN-bakker.
 Isolationstykkelse 100 mm på indkøringsmodellen for 20 stk. 2/1 GN-bakker
 Afrundede hjørner
 Højdejusterbare ben i rustfrit stål
 Selvlukkende vendbare døre, der kan åbnes 105°
Ergonomiske greb i fuld højde i rustfrit stål
 Magnet tætningslister – nemme at rengøre og udskifte
 Hyldevanger og hyldevinkler i rustfrit stål
 Elektronisk indstiksføler/temperaturspyd (ikke i modellen for 3 stk. 2/3 GN-bakker)
 Konstruerede for drift ved omgivelsestemperaturer på op til +43° C
 Coated fordampere (cataphoresis) for at modvirke tæring
Fuldt udskifteligt kølesystem
 Hot gas afrimning (dog manuel afrimning i modellen for 3 stk. 2/3 GN-bakker samt i alle modeller for separat kompressor)



3 stk. GN2/3



Side 85

5 stk. GN1/1



Side 86

14 stk. GN1/1



Side 90

6 stk. GN1/1



Side 87

20 stk. GN1/1



Side 91

7 stk. GN1/1



Side 88

20 stk. GN1/1 indkøringsmodel



Side 92

10 stk. GN1/1



Side 89

20 stk. GN2/1 indkøringsmodel



Side 93



Indbygget kompressor, luftkølet

W3TGO
W110200000



+90°C ⇒ +3°C

7 kg



+90°C ⇒ -18°C

5 kg



Vægt

50



Dimensioner

625×600×421

Pris i DKK

Ekskl. moms og afgifter

15.611,00



*Ford. -10°C kondens.45°C

Ei-tilslutning	230 / 50Hz
Kølekapacitet	635 W*
Optagen effekt	363 W
	2,2 A
Kølemiddel	R404a



Tropeudførelse

Isolation 50 mm



Ventileret køling

Luftafrimning



Tidsbaseret blæstkøling ved brug af føler

Blød blæstkøling +3°

Denne cyklus anbefales for lette produkter samt produkter med små dimensioner. Kerntemperaturen falder hurtigt samtidigt med, at produktoverfladen ikke beskadiges.



Hård blæstkøling +3°

Denne cyklus anbefales for fødevarer med store dimensioner, stor kompaktthed og stort fedtindhold.

Hård blæstkøling anvendes til hurtig nedkøling af produkter til en kerntemperatur på +3°C med negativ lufttemperatur i løbet af fase 1 (-20°C) og positiv lufttemperatur i løbet af fase 2.



Blæstfrysning -18°

Blæstfrysning er ideelt til at forlænge opbevaringstiden af friske eller netop tilberedte fødevarer.

Blæstfrysning anvendes til hurtig nedfrysning af produkter til en kerntemperatur på -18°C med en lufttemperatur på -40°C. Dette sikrer at fødevarernes kvalitet og konsistens bevares.



Når blæstkølings-/frysingscyklussen er tilendebragt går apparatet automatisk i lagringsposition. Lagertemperaturen bibeholdes indtil den tilendebringes manuelt.

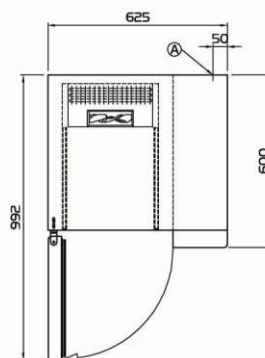
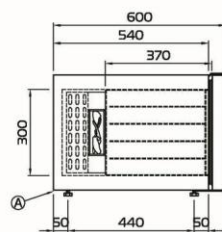
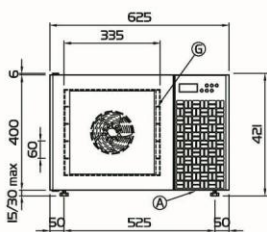

(A) POWER SUPPLY CABLE OUTLET

(G) RACKS PITCH



Catering

Blæstkølere/-frysere

5 stk. GN1/1

Dybde 700 mm



Indbygget kompressor, luftkølet

W5TGO
W110300000



+90°C ⇒ +3°C

14 kg



+90°C ⇒ -18°C

10 kg



Vægt

80



Dimensioner

710×700×840

Pris i DKK

Ekskl. moms og afgifter

23.078,00



For separat kompressor

W5TGOR
W110320000

+90°C ⇒ +3°C

14 kg

+90°C ⇒ -18°C

10 kg

Vægt

60

Dimensioner

710×700×840

Ekskl. moms og afgifter

19.391,00



Kompressoraggregat

F102117430

Max afstand 8 m

Vægt

25

Dimensioner

650×650×400

Ekskl. moms og afgifter

Indhent pris

*Ford. -10°C kondens.45°C

El-tilslutning	230 / 50Hz
Kølekapacitet	1528 W*
Optagen effekt	886 W
	4,9 A
Kølemiddel	R404a



+4.3°

Tropeudførelse



Ventileret køling



Højtryksafbryder



Hot gas afrimning



Isolation 60 mm



Elektronisk indstiksføler/temperaturspyd



Pumpdown ventil



Luftafrimning (for modeller med separat kompressor)

Blæstkøling/-frysning på to måder



1 Temperaturbaseret blæstkøling/-frysning ved brug af elektronisk indstiksføler/temperaturspyd



2 Tidsbaseret blæstkøling/-frysning

Blød blæstkøling +3°

Denne cyklus anbefales for lette produkter samt produkter med små dimensioner. Kerntemperaturen falder hurtigt samtidigt med, at produktoverfladen ikke beskadiges.



Hård blæstkøling +3°

Denne cyklus anbefales for fødevarer med store dimensioner, stor kompaktthed og stort fedtindhold.

Hård blæstkøling anvendes til hurtig nedkøling af produkter til en kerntemperatur på +3°C med negativ lufttemperatur i løbet af fase 1 (-20°C) og positiv lufttemperatur i løbet af fase 2.



Blæstfrysning -18°

Blæstfrysning er ideelt til at forlænge opbevaringstiden af friske eller netop tilberedte fødevarer.

Blæstfrysning anvendes til hurtig nedfrysning af produkter til en kerntemperatur på -18°C med en lufttemperatur på -40°C. Dette sikrer at fødevarernes kvalitet og konsistens bevares.



Når blæstkølings-/frysningscyklusen er tilendebragt går apparatet automatisk i lagringsposition. Lagertemperaturen bibeholdes indtil den tilendebringes manuelt.

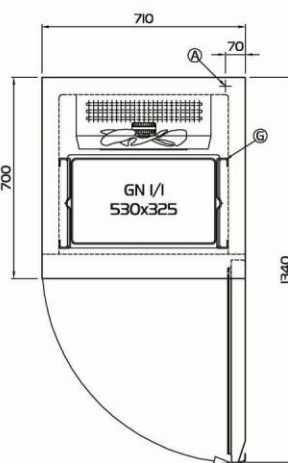
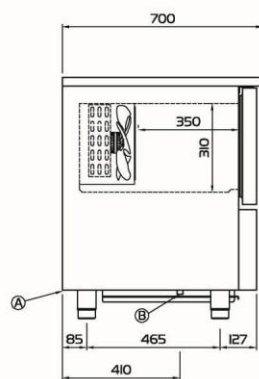
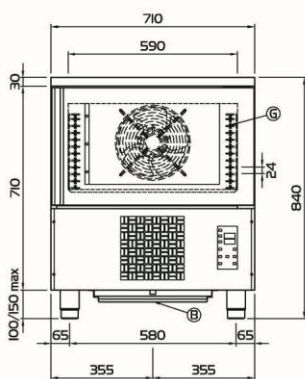

(A) POWER SUPPLY CABLE OUTLET

(B) CONDENSATION WATER DRAIN WITH REMOVABLE BASIN

(C) RACKS PITCH



HACCP grafisk lagringsenhed/printer



O842000040

6.340,00

UV sterilisering



O923200020

4.177,00

TILBEHØR

Opvarmet spyd



O923100020

2.760,00

Hjulsæt



O444000020

1.941,00

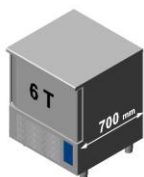

Indbygget kompressor, luftkølet

W6TGN
W110600000



+90°C ⇒ +3°C

18 kg



+90°C ⇒ -18°C

14 kg



Vægt

100



Dimensioner

710x700x900

Pris i DKK

Ekskl. moms og afgifter

28.443,00



For separat kompressor

W6TGNR
W110620000

+90°C ⇒ +3°C

18 kg

+90°C ⇒ -18°C

14 kg

Vægt

80

Dimensioner

710x700x900

Ekskl. moms og afgifter

24.081,00



Kompressoraggregat

F102120430

Max afstand 8 m

Vægt

25

Dimensioner

650x650x400

Ekskl. moms og afgifter

Indhent pris

*Ford. -10°C kondens.45°C

El-tilslutning	230 / 50Hz
Kølekapacitet	1755 W*
Optagen effekt	1088 W
	6 A
Kølemiddel	R404a



+43°

Tropeudførelse



Ventileret køling



Højtryksafbryder



Hot gas afrimning



Isolation 60 mm



Elektronisk indstiksføler/temperaturspyd



Pumpdown ventil



Luftafrimning (for modeller med separat kompressor)

Blæstkøling/-frysning på to måder



1 Temperaturbaseret blæstkøling/-frysning ved brug af elektronisk indstiksføler/temperaturspyd



2 Tidsbaseret blæstkøling/-frysning

Blød blæstkøling +3°

Denne cyklus anbefales for lette produkter samt produkter med små dimensioner. Kerntemperaturen falder hurtigt samtidigt med, at produktoverfladen ikke beskadiges.



Hård blæstkøling +3°

Denne cyklus anbefales for fødevarer med store dimensioner, stor kompaktthed og stort fedtindhold.
Hård blæstkøling anvendes til hurtig nedkøling af produkter til en kerntemperatur på +3°C med negativ lufttemperatur i løbet af fase 1 (-20°C) og positiv lufttemperatur i løbet af fase 2.



Blæstfrysning -18°

Blæstfrysning er ideelt til at forlænge opbevaringstiden af friske eller netop tilberedte fødevarer.
Blæstfrysning anvendes til hurtig nedfrysning af produkter til en kerntemperatur på -18°C med en lufttemperatur på -40°C. Dette sikrer at fødevarernes kvalitet og konsistens bevares.



Når blæstkølings-/frysningscyklussen er tilendebragt går apparatet automatisk i lagringsposition. Lagertemperaturen bibeholdes indtil den tilendebringes manuelt.

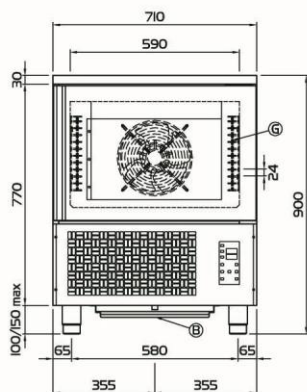

(A) POWER SUPPLY CABLE OUTLET

(B) CONDENSATION WATER DRAIN WITH REMOVABLE BASIN

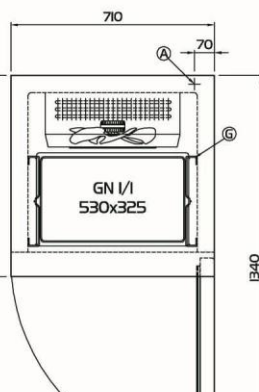
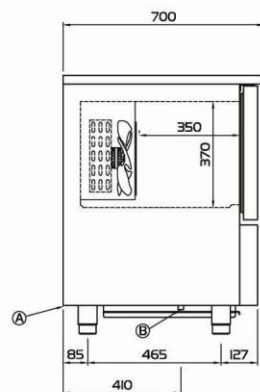

(C) RACKS PITCH

HACCP grafisk lagringsenhed/printer



O84200040

6.340,00

UV sterilisering



O923200020

4.177,00

TILBEHØR

Opvarmet spyd



O923100020

2.760,00

Hjulsæt



O444000020

1.641,00



Pris i DKK

Indbygget kompressor, luftkølet

W7TGN
W110700000
W110710000

+90°C ⇒ +3°C

25 kg

+90°C ⇒ -18°C

18 kg

Vægt

110

Dimensioner

710x700x1080

Ekskl. moms og afgifter

33.063,00



For separat kompressor

W7TGNR
W110720000

+90°C ⇒ +3°C

25 kg

+90°C ⇒ -18°C

18 kg

Vægt

90

Dimensioner

710x700x1080

Ekskl. moms og afgifter

28.708,00



Kompressoraggregat

F102122410

Max afstand 8 m

Vægt

25

Dimensioner

650x650x400

Ekskl. moms og afgifter

Indhent pris

*Ford. -10°C kondens.45°C

Ei-tilslutning	230 / 50Hz
Kølekapacitet	2084 W*
Oplageneffekt	1096 W
	6,1 A
Kølemiddel	R404a



Tropeudførelse



Isolation 60 mm



Ventileret køling



Elektronisk indstiksføler/temperaturspyd



Højtryksafbryder



Pumpdown ventil



Hot gas afrimning



Luftafrimning (for modeller med separat kompressor)

Blæstkøling/-frysning på to måder



1 Temperaturbaseret blæstkøling/-frysning ved brug af elektronisk indstiksføler/temperaturspyd



2 Tidsbaseret blæstkøling/-frysning

Blød blæstkøling +3°

Denne cyklus anbefales for lette produkter samt produkter med små dimensioner. Kerntemperaturen falder hurtigt samtidigt med, at produktoverfladen ikke beskadiges.



Hård blæstkøling +3°

Denne cyklus anbefales for fødevarer med store dimensioner, stor kompaktthed og stort fedtindhold.

Hård blæstkøling anvendes til hurtig nedkøling af produkter til en kerntemperatur på +3°C med negativ lufttemperatur i løbet af fase 1 (-20°C) og positiv lufttemperatur i løbet af fase 2.



Blæstfrysning -18°

Blæstfrysning er ideelt til at forlænge opbevaringstiden af friske eller netop tilberedte fødevarer.

Blæstfrysning anvendes til hurtig nedfrysning af produkter til en kerntemperatur på -18°C med en lufttemperatur på -40°C. Dette sikrer at fødevarernes kvalitet og konsistens bevares.



Når blæstkølings-/frysningscyklussen er tilendebragt går apparatet automatisk i lagringsposition. Lagertemperaturen bibeholdes indtil den tilendebringes manuelt.

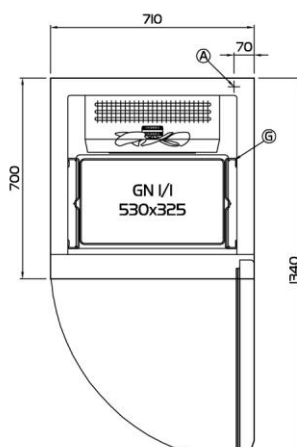
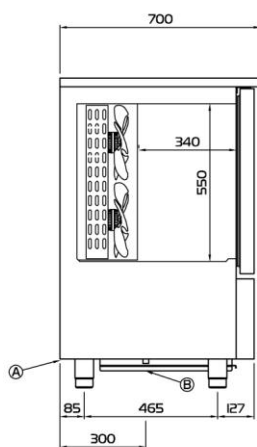
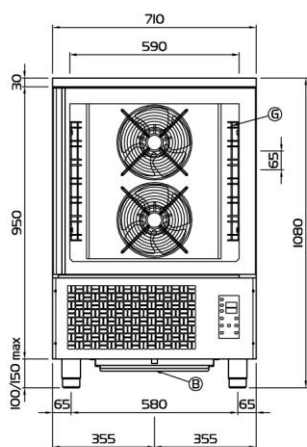

(A) POWER SUPPLY CABLE OUTLET

(B) CONDENSATION WATER DRAIN WITH REMOVABLE BASIN

(C) RACKS PITCH

x7

HACCP grafisk lagringsenhed/printer



O842000040

6.340,00

UV sterilisering



O923200020

4.177,00

TILBEHØR

Opvarmet spyd



O923100020

2.760,00

Hjulsæt



O444000020

1.641,00

Catering

Blæstkølere/-frysere

10 stk. GN1/1

Dybde 800 mm

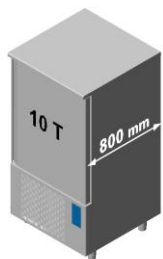

Indbygget kompressor, luftkølet

W10TGN
W111000000



+90°C ⇒ +3°C

40 kg



+90°C ⇒ -18°C

28 kg



Vægt

140



Dimensioner

780x800x1545

Pris i DKK

Ekskl. moms og afgifter

45.212,00



For separat kompressor

W10TGNR
W111020000

+90°C ⇒ +3°C

40 kg

+90°C ⇒ -18°C

28 kg

Vægt

110

Dimensioner

780x800x1545

Ekskl. moms og afgifter

34.412,00

Kompressoraggregat



F140404040

Max afstand 8 m

Vægt

25

Dimensioner

750x750x400

Ekskl. moms og afgifter

Indhent pris

*Ford. -10°C kondens.45°C

El-tilslutning	400V 3N / 50Hz
Kølekapacitet	5211 W*
Optagen effekt	3345 W
	6,2 A
Kølemiddel	R404a



+43°

Tropeudførelse



Ventileret køling



Højtryksafbryder



Hot gas afrimning



60

Isolation 60 mm



Elektronisk indstiksføler/temperaturspyd



Pumpdown ventil



Luftafrimning (for modeller med separat kompressor)

Blæstkøling/-frysning på to måder



1 Temperaturbaseret blæstkøling/-frysning ved brug af elektronisk indstiksføler/temperaturspyd



2 Tidsbaseret blæstkøling/-frysning

Blød blæstkøling +3°

Denne cyklus anbefales for lette produkter samt produkter med små dimensioner. Kernetemperaturen falder hurtigt samtidigt med, at produktoverfladen ikke beskadiges.



Hård blæstkøling +3°

Denne cyklus anbefales for fødevarer med store dimensioner, stor kompaktthed og stort fedtindhold.

Hård blæstkøling anvendes til hurtig nedkøling af produkter til en kernetemperatur på +3°C med negativ lufttemperatur i løbet af fase 1 (-20°C) og positiv lufttemperatur i løbet af fase 2.



Blæstfrysning -18°

Blæstfrysning er ideelt til at forlænge opbevaringstiden af friske eller netop tilberedte fødevarer.

Blæstfrysning anvendes til hurtig nedfrysning af produkter til en kernetemperatur på -18°C med en lufttemperatur på -40°C. Dette sikrer at fødevarernes kvalitet og konsistens bevares.



Når blæstkølings-/frysningscyklussen er tilendebragt går apparatet automatisk i lagringsposition. Lagertemperaturen bibeholdes indtil den tilendebringes manuelt.

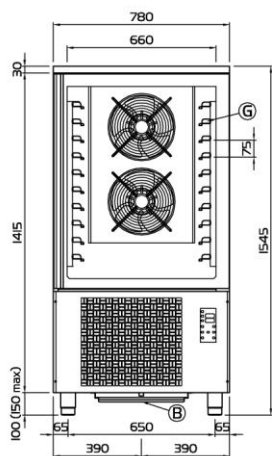

(A) POWER SUPPLY CABLE OUTLET

(B) CONDENSATION WATER DRAIN WITH REMOVABLE BASIN

(G) RACKS PITCH

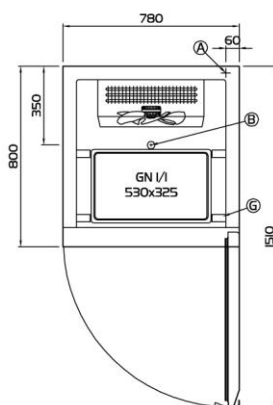
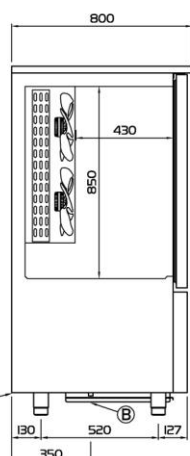

HACCP grafisk lagringsenhed/printer



O842000040

6.340,00

UV sterilisering



O923200020

4.177,00

TILBEHØR

Opvarmet spyd



O923100020

2.760,00

Hjulsæt



O444000020

1.641,00



					Pris i DKK
Indbygget kompressor, luftkølet W14TGN W111400000	+90°C ⇒ +3°C 50 kg	+90°C ⇒ -18°C 35 kg	Vægt 160	Dimensioner 780x800x1765	Ekskl. moms og afgifter 51.519,00
					Ekskl. moms og afgifter
For separat kompressor W14TGNR W111420000	+90°C ⇒ +3°C 50 kg	+90°C ⇒ -18°C 35 kg	Vægt 130	Dimensioner 780x800x1765	40.718,00
	Kompressoraggregat F140404040		Vægt 25	Dimensioner 750x750x400	Ekskl. moms og afgifter Indhent pris

*Ford. -10°C kondens.45°C

El-tilslutning	400V 3N / 50Hz
Kølekapacitet	6013 W*
Optagen effekt	3440 W
	6,6 A
Kølemiddel	R404a

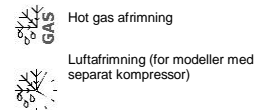
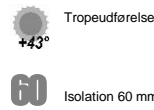

Blæstkøling/-frysning på to måder



1 Temperaturbaseret blæstkøling/-frysning ved brug af elektronisk indstiksføler/temperaturspyd



2 Tidsbaseret blæstkøling/-frysning

Blød blæstkøling +3°	Hård blæstkøling +3°	Blæstfrysning -18°
<p>Denne cyklus anbefales for lette produkter samt produkter med små dimensioner. Kernetemperaturen falder hurtigt samtidigt med, at produktoverfladen ikke beskadiges.</p>	<p>Denne cyklus anbefales for fødevarer med store dimensioner, stor kompaktthed og stort fedtindhold.</p> <p>Hård blæstkøling anvendes til hurtig nedkøling af produkter til en kernetemperatur på +3°C med negativ lufttemperatur i løbet af fase 1 (-20°C) og positiv lufttemperatur i løbet af fase 2.</p>	<p>Blæstfrysning er ideelt til at forlænge opbevaringstiden af friske eller netop tilberedte fødevarer.</p> <p>Blæstfrysning anvendes til hurtig nedfrysning af produkter til en kernetemperatur på -18°C med en lufttemperatur på -40°C. Dette sikrer at fødevarernes kvalitet og konsistens bevares.</p>



Når blæstkølings-/frysningscyklussen er tilendebragt går apparatet automatisk i lagringsposition. Lagertemperaturen bibeholdes indtil den tilendebringes manuelt.

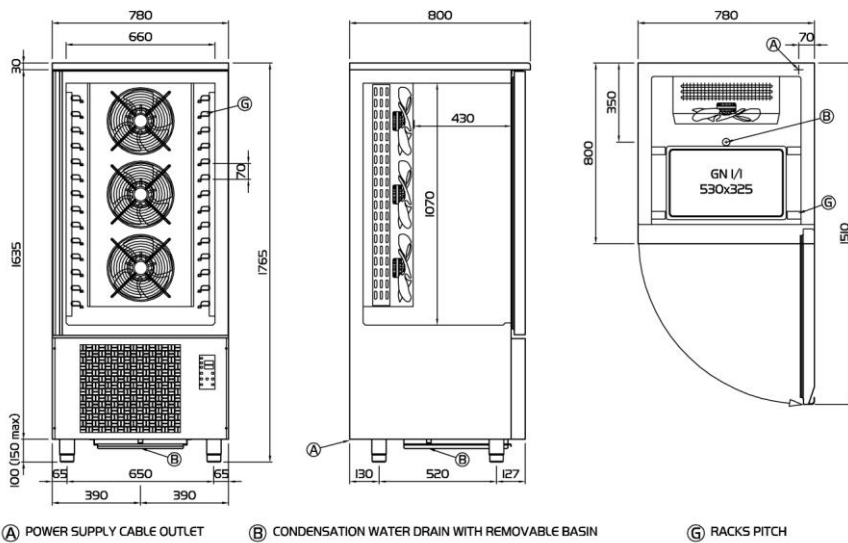



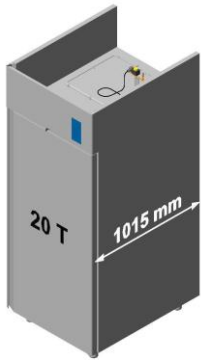

HACCP grafisk lagringsenhed/printer O842000040 6.340,00	UV sterilisering O923200020 4.177,00
--	---

TILBEHØR

Opvarmet spyd O923100020 2.760,00	Hjulsæt O444000020 1.641,00
--	--



					Pris i DKK
For separat kompressor W20TGNR W112020000	+90°C ⇒ +3°C 80 kg	+90°C ⇒ -18°C 55 kg	Vægt 170	Dimensioner 810×1015×2085	Ekskl. moms og afgifter 63.572,00

Voltage	400V 3N / 50Hz
Cooling capacity	9702 W*
Total rate	5590 W
Total output	16,4 A
Cooling gas	R404a

*Evap. -10°C cond. 45°C

Kompressoraggregat F102113520	Luftkølet Max distance 8 m	Vægt 80	Dimensioner 800×600×550	Ekskl. moms og afgifter Indhent pris
---	-------------------------------	------------	----------------------------	--

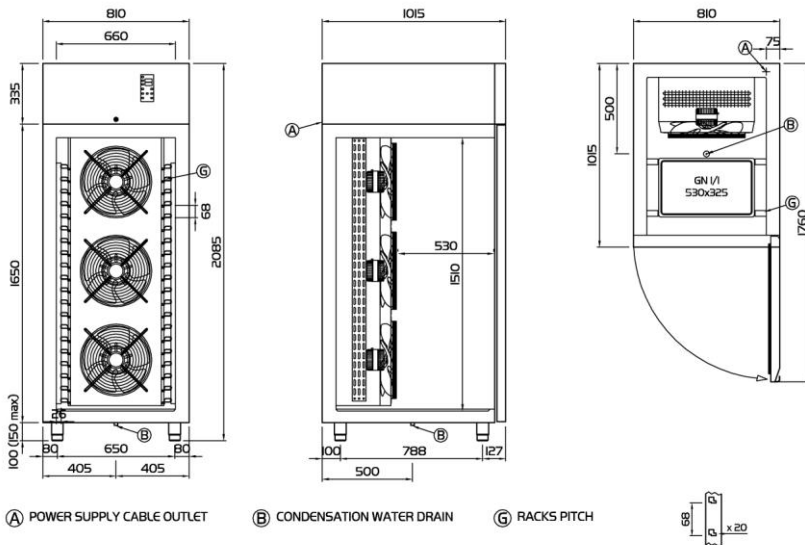
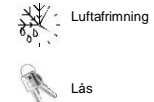
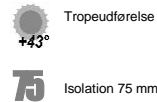





HACCP grafisk lagringsenhed/printer 	UV sterilisering 
O842000040 6.340,00	O923200020 4.177,00

TILBEHØR



Opvarmet spyd 	Hjulsæt 
O923100020 2.760,00	O444000020 1.641,00

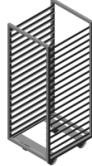

					Pris i DKK
For separat kompressor W20KGNR W122020000	+90°C ⇒ +3°C 80 kg	+90°C ⇒ -18°C 55 kg	Vægt 170	Dimensioner 810x1015x2115	Ekskl. moms og afgifter 68.942,00

20 GN1/1



		Pris i DKK
Indkøringsvogn O660901020	Vægt 40 Dimensioner 598x530x1630	Ekskl. moms og afgifter Ved bestilling med blæstkøler 6.146,00

Kompressoraggregat F102113520	Luftkølet Max afstand 8 m	Vægt 80	Dimensioner 800x600x550	Ekskl. moms og afgifter Indhent pris
---	------------------------------	------------	----------------------------	--

Ei-tilslutning	400V 3N / 50Hz
Kølekapacitet	9702 W*
Optagen effekt	5590 W
	16,4 A
Kølemiddel	R404a

*Ford. -10°C kondens.45°C

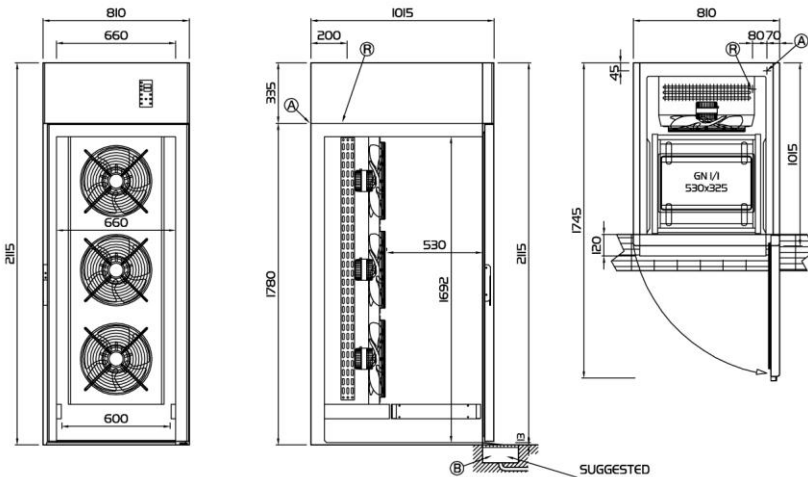
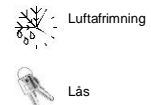
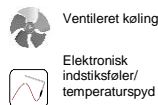
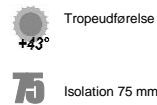

A POWER SUPPLY CABLE OUTLET

B CONDENSATION WATER DRAIN

R GAS PIPES OUTPUT

HACCP grafisk lagringsenhed/printer	UV sterilisering
-------------------------------------	------------------



O842000040

6.340,00



O923200020

4.177,00

TILBEHØR





Opvarmet spyd	
---------------	--

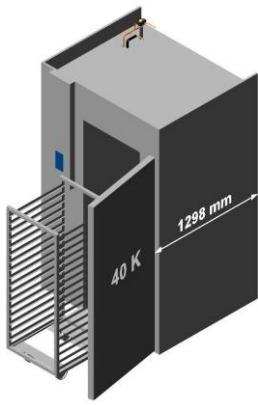

O923100020



2.760,00

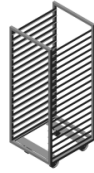

					Pris i DKK
For separat kompressor W40KGNR W132020000	+90°C ⇒ +3°C	+90°C ⇒ -18°C	Vægt 200	Dimensioner 1400×1298×2340	Ekskl. moms og afgifter 98.847,00
	120 kg	80 kg			

20 GN2/1
40 GN1/1



		Pris i DKK
Indkøringsvogn O660904040	Vægt 40 Dimensioner 660×720×1750	Ekskl. moms og afgifter Ved bestilling med blæstkøler 6.422,00

Kompressoraggregat F102128420	Luftkølet Max afstand 8 m	Vægt 90	Dimensioner 1050×700×540	Ekskl. moms og afgifter Indhent pris
---	------------------------------	------------	-----------------------------	--

Ei-tilslutning	400V 3N / 50Hz
Kølekapacitet	12470 W*
Optagen effekt	6480 W
	19 A
Kølemiddel	R404a

*Ford. -10°C kondens.45°C



Trapeudførelse

+43°

Isolation 100 mm



Ventileret køling



Elektronisk indstiksføler/temperaturspyd



Højtryksafbryder



Pumpdown ventil



Luftafrimning

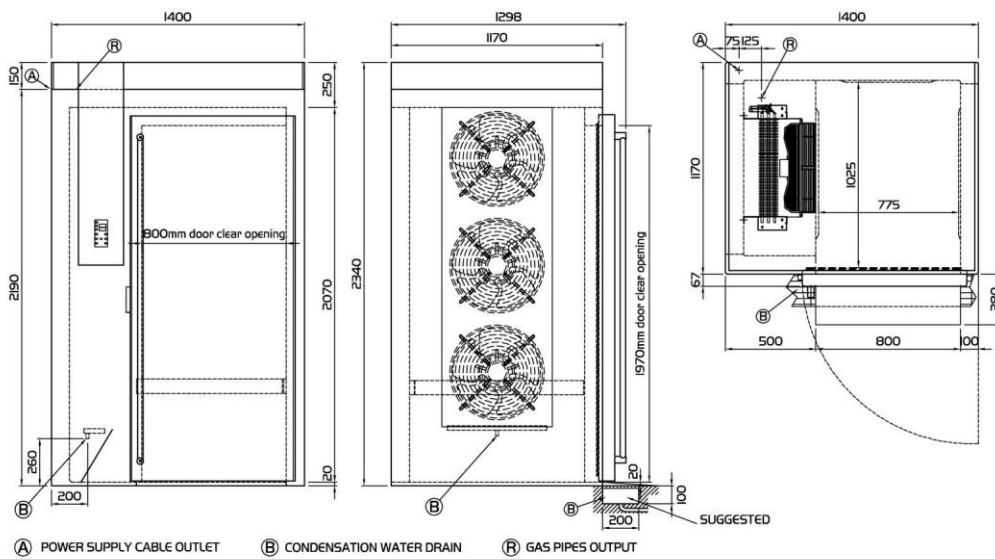

HACCP grafisk lagringsenhed/printer	UV sterilisering
	
O842000040	O923200020
6.340,00	4.177,00

TILBEHØR

Opvarmet spyd	
	
O923100020	
2.760,00	

FastShop.dk - 35 81 67 00